



# User Manual Ethernet over COAX

Controller / Endpoint EPC & EPE / MediaConverter 1 / RP filters

Article				Article no.
Ethernet Over COAX	Controller 32/64			383101/103
	Controller 32/64 – Rev.B			383104/105
	Endpoint EPC / EPE			383200/230
	MediaConverter 1			383235
	RP filters			383900/903
Version	1.6 890907D	Date	02/2020	EN

---

<b>1.</b>	<b>The EoC solution .....</b>	<b>3</b>
	EoC Controller.....	4
	EoC Return path (RP) filter .....	5
	EoC Coax Endpoint (EPC) .....	6
	EoC Ethernet Endpoint (EPE) .....	6
	EoC MediaConverter (EMC) .....	7
<b>2.</b>	<b>Installation.....</b>	<b>8</b>
<b>3.</b>	<b>Controller setup .....</b>	<b>10</b>
	Operation.....	10
	LEDs on controller.....	10
	Reset.....	10
<b>4.</b>	<b>Endpoint (EPC) setup.....</b>	<b>11</b>
	Operation.....	11
	LEDs on endpoint .....	11
	Reset.....	11
<b>5.</b>	<b>Endpoint (EPE) setup.....</b>	<b>11</b>
	Operation.....	11
	LEDs on endpoint .....	11
	Reset.....	12
	PoE Switch settings .....	12
<b>6.</b>	<b>Endpoint interface .....</b>	<b>12</b>
	Easy setup w/ QR code.....	12
<b>7.</b>	<b>MediaConverter (EMC) setup .....</b>	<b>13</b>
	Initial setup between MediaConverter and EoC controller.....	13
	Easy setup w/ QR code .....	13
	Status of the MediaConverter .....	13
<b>8.</b>	<b>Initial setup of Controller and Endpoints w/ ethernet cable .....</b>	<b>14</b>
	Configuration wizard.....	14
<b>9.</b>	<b>Controller interface (GUI).....</b>	<b>15</b>
	Network.....	16
	System.....	21
	Performance .....	22
<b>10.</b>	<b>Support &amp; installation report .....</b>	<b>22</b>

---

## Safety Instructions

**Failure to comply** with the specified precautionary measures may cause serious injury to persons or damage to property. The installation and commissioning may only be performed by suitably qualified persons, technicians or installers in compliance with safety regulations. Damage due to improper installation and commissioning, defective connectors on cables or any other incorrect handling will void the warranty.

CAUTION: The safety requirements are according to EN 60728-11 and must be observed.

- Disconnect mains power before working on electrical systems.
- Any additional electrical wiring requirements should always be installed by a suitably qualified person(s).

Installation or service work should NEVER be undertaken during electrical / thunderstorms.



### To prevent fire, short circuit or shock hazard

- Do not expose the unit to rain or moisture.
- Install the unit in a dry location without infiltration or condensation of water.
- Do not expose it to dripping or splashing.
- If any liquid should accidentally fall into the cabinet, disconnect the power plug.



### To avoid any risk of overheating

- Install the unit in a well aired location and keep a minimum distance around the apparatus for sufficient ventilation
- Do not place anything on the unit that might cover the ventilation holes.
- Do not install the product in a dusty place
- Use the apparatus only in moderate climates (not in tropical climates)
- Respect the minimum and maximum temperature specifications



### To avoid any risk of electrical shocks

- Controller must be correctly grounded according to applicable national regulations
- The mains plug shall remain readily operable
- Pull out power plug when making connections of cables
- To avoid electrical shock, do not open the housing.



### To avoid interferences with LTE services in Europe

- Do not select a channel higher than UHF 48 in countries with LTE II / 700 operation
- Do not select a channel higher than UHF 60 in countries with LTE I / 800 operation
- Use coaxial cables with screening effectiveness of >85dB (Class A) at least or >95dB (Class A+)



### WEEE disposal



This product may not be disposed of with general household waste  
Follow applicable national legislation when disposing of this product

## 0. Revision history

1.6	Adding streaming possibilities with the <b>MediaConverter</b>
1.5	Combining of EoC out ports – facilitates from 17...64 Endpoints on a single COAX line
1.4	New controllers, adding combining up to 64 EP's on same COAX, reset button and status LED's on front. <b>Controller and SW version 2.1 and onwards, is fully backwards compatible to previous controllers.</b>
1.3	Adding Ethernet (EP-E) endpoint w/ PoE out
1.2	Minor changes
1.1	Minor changes
1.0	First release

## 1. The EoC solution

Ethernet over Coax (EoC) allows ethernet traffic to be sent over a coax network in coexistence with TV signals. EoC is a straightforward system, well suited for retro-fitting into an existing coax installation with no or minor modifications.

The EoC Coax Endpoints (EPC) are professional WiFi access points. EoC with WiFi is an easy way to build a reliable and powerful WiFi solution, that is completely managed by the EoC Controller.

TRIAX also provides Endpoints with WiFi (EPE) that can be connected over traditional Ethernet infrastructure (CAT cables) and powered over Ethernet. TRIAX EoC is a complete WiFi solution, that builds on the two most common cable infrastructures used today, all managed by the same EoC Controller.

For EoC installations without WiFi support – the EoC MediaConverter is used.

EoC can also be used in combination with a TRIAX In Touch managed solution to add layer 3 functionality.

This gives the user a managed In Touch solution where the Internet bandwidth per device can be controlled; as well as providing a range of value added services.

For In Touch and EoC solutions, see showcases & information here: <https://solutions.triax.com>

### Abbreviations

TRIAX EoC	Ethernet over Coax – the easy way of transporting High Speed Ethernet via your COAX
TRIAX In Touch	Information displayed - at your convenience <b>where</b> you need it, <b>when</b> you need it and <b>whatever</b> you need.
EPC	EoC Coax Endpoint (endpoint fed with a COAX input)
EPE	EoC Ethernet Endpoint (endpoint fed with a Ethernet input)
EMC	EoC MediaConverter (High Speed Ethernet to your hospitality TV)
RP	Return Path filter
Rack size 19HE	19 Inch "height-unit" (suitable for 19" rack)
SSID	Service Set Identifier
VLAN	Virtual LAN
SW	Software
SN	Serial Number
MAC address	Media Access Control address
PHY	Physical Layer
GUI	Graphical User Interface
TCP	Transmission Control Protocol
QR	QR code to be read by your smartdevice (smartphone or tablet)

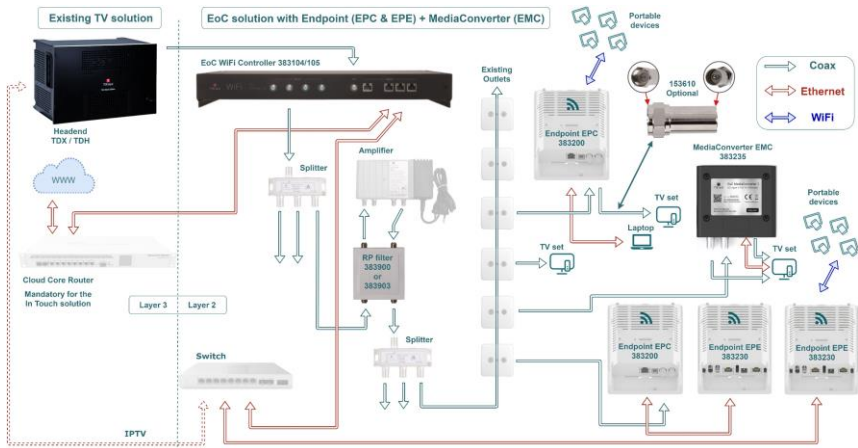

## Overview of components



## EoC Controller

### Mounting

- Controller can be mounted and stacked in Rack (19HE), or wall mounted in any direction needed.
- Controller must be correctly grounded according to applicable national regulations.
- Ensure that min. 4 cm ventilation space is available on both sides of controller.



### EoC Return path (RP) filter 1...200 MHz / 2...85 MHz

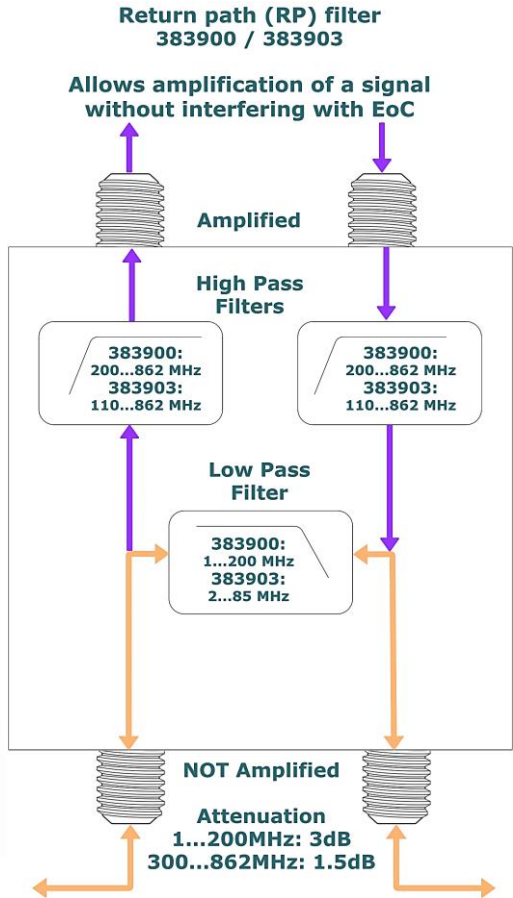

## EoC Coax Endpoint (EPC)

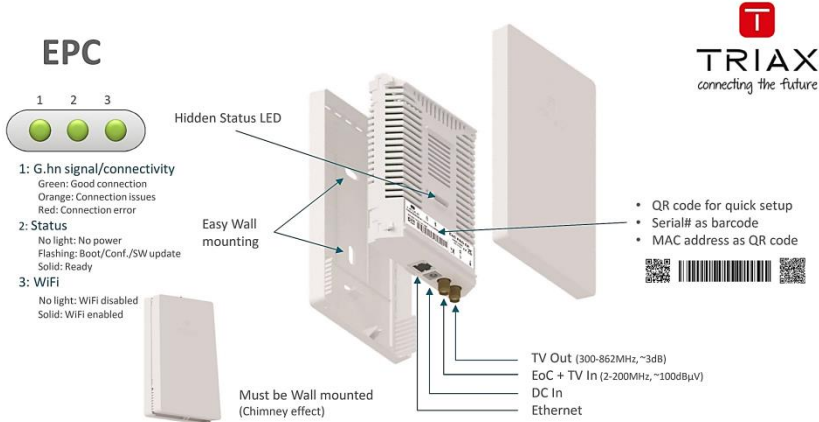

## EoC Ethernet Endpoint (EPE)

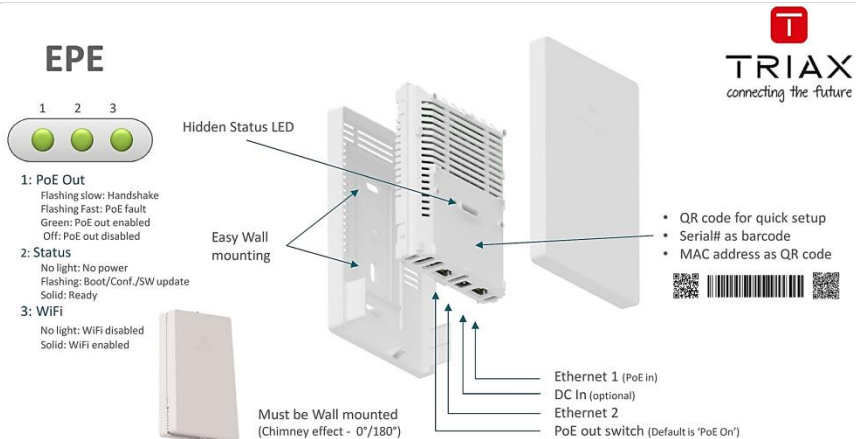

## Endpoints Mounting

For optimal WiFi coverage and for optimal cooling, always mount Endpoint(s) vertically on a wall as shown.

NB: the EoC Ethernet Endpoint can also be mounted upside down. This equipment complies with EU radiation exposure limits, set forth for an uncontrolled environment. This equipment should be installed and operated with minimum distance of 20 cm between the equipment and your body.



## EoC MediaConverter (EMC)

Green: G.hn on COAX OK  
Yellow: G.hn connection issues  
Red: G.hn on COAX failure

LED's will indicate status for ca. 15 min after power up, and then turn off.

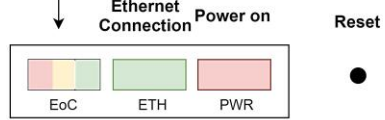

Easy setup w/ QR code  
(if smartdevice is on **same** VLAN  
as EoC controller)

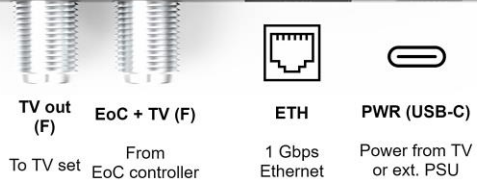



## 2. Installation



To install the EoC controller and endpoints it is recommended to use the following process:

Start with the controller:

- Mount controller and attach cabling.
- Use the controller interface to configure the system as needed or use the standard configuration (see chapter, Controller interface).

See also the accompanying **Quick Guide**, for more information.

Install RP filter if needed:

- Observe the wiring diagram.

Then install endpoints (EPC, EPE or MediaConverter):

- Mount the backplate of the endpoint.
- Attach cabling to EPC / EPE / or MediaConverter
  1. EPC: Coax in / Coax out.
    - EPE: Ethernet in (PoE+).
  2. EPC: Power.
    - EPE: Data out (PoE).
  3. EPC: Ethernet (if needed).
    - EPE: Power (if needed).
- Place EPC / EPE in wallmount.
- Or fix the EMC to TV set
- Connect to the setup WiFi. (**TriaxSetup\_xxxx**)
- Scan the QR code and input.
  1. Login w/ admin account.
  2. Input Endpoint name and optional location / description.
  3. Choose configuration group.
- Close the installation with the coverplate and you are done.

Using this process will allow for easier configuration of the endpoints, as the specific configuration groups have already been set up and there is no need for individual setup of the endpoints, just choose the correct configuration group and you are done.

### Physical connection to standard configuration groups

#### Private network

Connect a CAT cable from your router/modem to port 2 on the controller.  
 This will allow any endpoint with the "Private only" or "Guest & Private" configuration to send out a WiFi (SSID Private) with Internet access.  
 On this network, devices can communicate with each other.  
 This Private network uses VLAN 50.

#### Guest network

Connect a CAT cable from your router/modem to port 3 on the controller.  
 This will allow any endpoint with the "Guest only" or "Guest & Private" configuration to send out a WiFi (SSID Guest) with Internet access.  
 On this network, it is not possible for devices to see each other or share data, as client isolation is activated.  
 This Guest network uses VLAN 100.

#### IP TV network

Connect IP TV signal to ethernet port 4 on the controller. The TV signal will then be sent out on the ethernet port of any endpoint with the "Guest only", "Private only" or "Guest & Private" configuration. This IP TV network uses VLAN 80.

- For logical setup in the graphical user interface (GUI), see chapter 9.

### MediaConverter 1, installation on back of TV set

Find a suitable position on back of TV set. The enclosed L-shape bracket can be mounted in different positions on the EoC MediaConverter. Select the best fitted position to accommodate for the TV set. Typically TV sets offer several threaded fixation holes that can be used (ie. for wall mount, or stand)

Cabling are more easy connected on the EoC MediaConverter before fixation. See illustration:

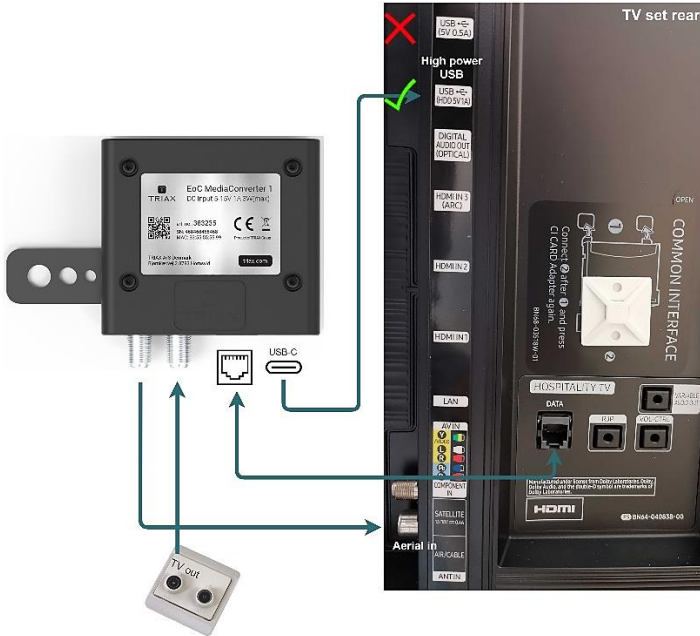

Once cabling is connected and tightened properly, the EoC MediaConverter can be fixed to the TV set. A typical Hotel TV offers either a High Power USB 2.0 port (min. 600mA), a USB 3.0 port or a 12 Vdc connector; from where the EoC MediaConverter can be powered.

If there are no possibilities to power from the TV set directly, an external power adapter can be installed. NB: Do not power the EoC MediaConverter from a standard USB 2.0 port – the output power may not be sufficient for correct and continued operation.

#### Enclosed label

The purpose of the enclosed ID labels is to remember/document at which location/room, the EoC MediaConverter is installed. A label is enclosed in the package with every EoC MediaConverter. An Installation Report, enclosed last in this manual or to be downloaded at our website for the EoC products, can be used to document the installation. After installation the label can be attached to the Installation report with further info, regarding location/room. Thus the Installation Report can serve, not only as documentation, but also as guideline when single parts of the EoC system, has to be mended or setup again.



### 3. Controller setup

#### Operation

The controller acts as a layer 2 Switch with a built in media converter. Therefore, it is intended that a router is connected to the controller ethernet ports, facilitating IP address management (DHCP) and providing Internet access w/ firewall. It supports up to 70 endpoints.

#### F-connector Ports

- The TV in port allows for TV signals in the 300-862 MHz range.
- The EoC out ports communicate using network (data) signals on 2-200 MHz and send out TV signals on 300-862 MHz. The TV and network (data) signals will be split again at the endpoint. Each EoC out port can support up to 16 endpoints. If more than 16 endpoints are connected to a single EoC out port, then any endpoints above the 16<sup>th</sup> connected will not function.
- It is possible to combine the EoC out ports with each other – to facilitate up to 64 Endpoints on a single COAX (*only for controller rev. B*)

#### LEDs on controller

##### EoC Out

- No light: No network data connection to the endpoint(s).
- Flashing light: Communicating with the endpoint(s).
- Solid light: Network data connection to endpoint(s) established.
- Colour Green: Good working connection.
- Colour Orange/Yellow: Connection issues (poor signal or authentication issues).
- Colour Red: Connection error (very poor signal).

##### Power

- No light: Controller is OFF
- Light: Controller is ON

#### Reset

To the right of the controller, above the LED, is an access to the reset button. (use ie. the tip of a pen, to activate)

The reset button has 3 functions:

- When controller is running, a **short press** (<3 sec) will **reboot** the controller.
- When controller is running, a **long press** (>3 sec) will reset the controller to **factory settings**.
  - all configuration changes are revoked back to default.
  - SW version installed will **not** be affected.
- When controller is **OFF**, a press on reset button + powering up at the same time; will make a **SW recovery**.
  - SW will be overwritten to **original SW** (controller has a copy of original SW)
  - all configuration changes are revoked back to default.



## 4. Endpoint (EPC) setup

### Operation

The COAX endpoint is a dual band WiFi access point. Each endpoint has two RF ports, EoC + TV and TV out. The EoC + TV port communicates using network (data) signals on 2-200 MHz and receives TV signals on 300-862 MHz. The endpoint splits the signals into network data, accessible through ethernet and WiFi, and TV out.

### LEDs on endpoint

#### Signal

- No light: No network data connection to the controller.
- Flashing light: Communicating with the controller.
- Solid light: Network data connection to controller established.
- Colour Green: Good working connection.
- Colour Orange/Yellow: Connection issues (poor signal or authentication issues).
- Colour Red: Connection error (very poor signal).

#### Reset

To reset use a paper clip or similar, press the reset button a few seconds on the endpoint. This will trigger a reboot and remove the configuration data on the endpoint. After start up, the endpoint will automatically download the configuration from the controller, corresponding to the group the endpoint is assigned to.

#### Status

- No light: Endpoint is not powered on (main CPU not running).
- Flashing light:
  - Slow: Starting up or reboot
  - Fast: Configuration sync or SW updating.
- Solid light: Endpoint is powered on.

#### WiFi

- No light: WiFi is turned off.
- Flashing light: Indicates an error state.
- Solid light: WiFi is turned on.

## 5. Endpoint (EPE) setup

### Operation

The ethernet endpoint is a dual band WiFi access point. It is connected through the Ethernet input port, with PoE support for easy installation when there is not a power outlet nearby. In addition it has an Ethernet output port with PoE output, where it can be connected to a second endpoint or other IP connected device. The PoE output can be turned on/off by a Switch in the bottom of the Endpoint.

### LEDs on endpoint

#### PoE output status

- No light: No power on PoE output.
- Flashing light:
  - Slow: Handshake process in progress.
  - Fast: PoE fault.
- Solid light: PoE output power enabled.

#### WiFi

- No light: WiFi is turned off.
- Flashing light: Indicates an error state.
- Solid light: WiFi is turned on.

#### Status

- No light: Endpoint is not powered on. (main CPU not running).
- Flashing light:
  - Slow: Starting up or reboot.
  - Fast: Configuration sync or SW updating.
- Solid light: Endpoint is powered on.

## Reset

To reset use a paper clip or similar, press the reset button a few seconds on the endpoint. This will trigger a reboot and remove the configuration data on the endpoint.

After start up, the endpoint will automatically download the configuration from the controller, corresponding to the group the endpoint is assigned to.

## PoE Switch settings

ON: (default) PoE+ negotiated w/ PoE Switch, PoE output is enabled.

OFF: (power save) PoE negotiated w/ PoE Switch, for supply of EPE only. PoE output is disabled.

## 6. Endpoint interface

While connected to either the **TriaxSetup\_XXXX** WiFi SSID or to the controller setup interface on ethernet port 1, you can scan the setup QR code on an endpoint.

This will provide a link to access the endpoint installation page, hosted by the controller, for that specific endpoint.

You need to enter the controller admin password to continue. (see next chapter).

### Easy setup w/ QR code

While connected to the **TriaxSetup\_XXXX** WiFi SSID, there is a very easy way to setup a new Endpoint – scan the QR code (where it states “setup”), situated on the front of the endpoint casing.



This will provide a link to access to the controller setup page for that specific endpoint. You need to enter the controller admin password to continue. It is then possible to choose a configuration group for the endpoint and write in a name and/or location.

Alternative method:

The endpoint installation page can alternatively be accessed by using the following URL:

<http://setup.eoc/conf/AABBCCDDEEFF/SN> where letters are the MAC address and SN is the serial number.

Choosing a configuration group; same procedure as the above head line “Easy setup”.

Because the endpoint installation page is hosted by the controller; it can't be accessed if the endpoint is not connected to the controller, even though the TriaxSetup\_XXXX WiFi SSID's is available.

## 7. MediaConverter (EMC) setup

### Initial setup between MediaConverter and EoC controller

If the installation doesn't include TRIAX WiFi Endpoints (EPC, EPE), setup is done from a PC connected to the EoC controller or connected to the EoC MediaConverter directly.

This URL: <http://setup.eoc/conf/emc> will lead you to GUI of the EoC Controller. Connected MediaConverters will appear in the setup group and can be configured as desired.

First field is a drop down menu, showing all registered EoC Media Converters. The 4 characters after EMC\_\*\*\*\*, is the 4 last characters of the EoC MediaConverter MAC address.

MEDIA CONVERTER 30:1F:9A:70:F0:2A

Registered device:

Device name:

Location/Description:

Configuration group:

**Save & Apply**



### Easy setup w/ QR code

If present installation includes WiFi Endpoints, and if smartdevice is on same VLAN as EoC controller; it is very easy to setup the new EoC MediaConverter. Scan the QR code on the enclosed label of the EoC MediaConverter, and you will be connected with the setup part of the EoC Controller GUI. There you can assign name and location of the new EoC MediaConverter.

MEDIA CONVERTER 30:1F:9A:70:F0:2A

Registered device:

Device name:

Location/Description:

Configuration group:

**Save & Apply**

### Status of the MediaConverter

When setup is done, the status of the EoC MediaConverter, is shown at the EoC Controller GUI "System Status"

Name	Status	Group	Info	Network Usage	Data	Reboot
EMC_f004	OK	Private only	Model: EoC Media Converter endpoint SW: 2.3.3.r113 MAC: 30:1f:9a:70:f0:04 S/N: 38323502201948004	Ethernet link: Not connected Ethernet Rx/Tx: 0/0 kB/s G.hn Rx/Tx: 0/0 kB/s	EoC out: 3 Po/Tx: 1760/1745 Mbps	Reboot
EMC_f020	OK	Private only	Model: EoC Media Converter Endpoint SW: 2.3.3.r113 MAC: 30:1f:9a:70:f0:28 S/N: 383235022019480040	Ethernet link: Not connected Ethernet Rx/Tx: 0/0 kB/s G.hn Rx/Tx: 0/0 kB/s	EoC out: 3 Po/Tx: 1779/1720 Mbps	Reboot

Name	Status	Info	Network Usage
EMC_f004	OK	Model: EoC Media Converter Endpoint SW: 2.3.3.r113 MAC: 30:1f:9a:70:f0:04 S/N: 38323502201948004	Ethernet link: Not connected Ethernet Rx/Tx: 0/0 kB/s G.hn Rx/Tx: 0/0 kB/s
EMC_f028	OK	Model: EoC Media Converter Endpoint SW: 2.3.3.r113 MAC: 30:1f:9a:70:f0:28 S/N: 383235022019480040	Ethernet link: Not connected Ethernet Rx/Tx: 0/0 kB/s G.hn Rx/Tx: 0/0 kB/s

## 8. Initial setup of Controller and Endpoints w/ ethernet cable

It is possible to access the web interface by connecting a PC via ethernet to port 1 on the controller. Open a browser and type in <https://setup.eoc> and type in the admin username and password. By default this is admin/admin, but is usually changed through the configuration wizard.

After changing any settings, you must press the Save & Apply button, before the specific settings takes effect on the endpoint or controller. In the top right corner of the controller interface you will see a red disk if there are settings that have been changed but not applied yet. If the disk is green all settings have been saved and applied. Changes done in the configuration wizard are automatically saved and applied, after clicking "Finish" on the last page.

### Configuration wizard

When accessing the controller interface **first time**, the configuration wizard welcome page will be shown. (In case this is not automatically shown, it can be accessed at: [https://setup.eoc/config\\_wizard](https://setup.eoc/config_wizard)) At the configuration wizard welcome page you have the possibility to choose either:

- Configuration wizard: this will take you through the most common configuration options:
  - Administrator account settings.
  - Checking internet connection.
  - Software update.
  - Date & time settings.
  - Restore/import configuration from backup.
  - G.hn filters.
  - WiFi settings.
  - Configuration groups.
- Configure manually: skip the configuration wizard.

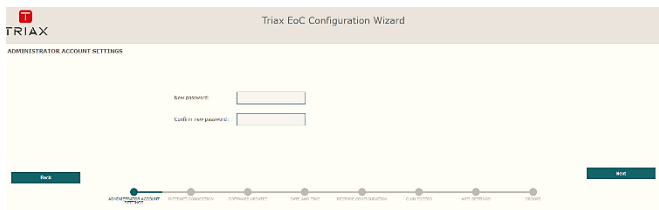

After completion of the configuration, the wizard will not automatically be started again.

## 9. Controller interface (GUI)

Login to EoC controller GUI – you will be greeted by the EoC dashboard Status, where system data for controller and endpoints can be monitored.

Address is: <https://setup.eoc>

Input username and password.

Default: admin/admin – remember to change after first login.

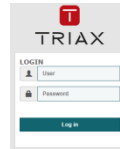

### Dashboard

In the dashboard you will be met by 4 panes

- Status – information of System, WiFi client, and Ethernet clients.
- Network – changing of settings for the network infrastructure.
- System – other settings, apart from network related, can be set here.
- Performance – conducting TCP traffic tests.

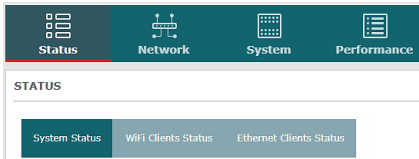

The controller G.hn ports status table gives an overview of how the endpoints, connected via COAX, are distributed among the EoC out COAX ports. An Endpoint is counted as "Online" when the controller EoC out port has established a connection to the Endpoint.

The "registered" counter reflects the controller Endpoints database, and can therefore be higher than the possible number of "online" Endpoints.

Normally the "online" counter should be equal to or less than the "registered" counter, for each EoC out port.

If not, this may indicate issues.

Additionally the table shows the bandwidth of the controller EoC out ports, and if the EoC out ports have been configured for combining, it is shown in the "Combine Group" section.

#### G.HN PORTS

Port Name	MAC Address	Combine Group	Endpoints (Online / Registered)	Tx / Rx Bandwidth, Mbps
EoC out #1	30:1f:9a:70:b8:60	A	1 / 4	0.0 / 0.0
EoC out #2	30:1f:9a:70:b8:61	A	16 / 13	0.7 / 0.5
EoC out #3	30:1f:9a:70:b8:62	A	0 / 0	0.0 / 0.0
EoC out #4	30:1f:9a:70:b8:63	A	0 / 0	0.0 / 0.0

#### ENDPOINTS

Name	Status	Group	Info	Network Usage	Data	Reset
EPC_0014	offline	Guest only	Model: EoC Coax WiFi Endpoint SW: MAC: 00:13:9d:bb:00:14 S/N: 383200002017400014	Ethernet link: WiFi Rx/Tx: 0/0 kB/s Ethernet Rx/Tx: 0/0 kB/s G.hn Rx/Tx: 0/0 kB/s	EoC out: 1 Rx/Tx: 0/0 Mbps	Reset
EPC_0007	offline	Private only	Model: EoC Coax WiFi Endpoint SW: MAC: 00:13:9d:bb:00:07 S/N: 383200002017100007	Ethernet link: WiFi Rx/Tx: 0/0 kB/s Ethernet Rx/Tx: 0/0 kB/s G.hn Rx/Tx: 0/0 kB/s	EoC out: 1 Rx/Tx: 0/0 Mbps	Reset
EPC_01a2	offline	Guest only	Model: EoC Coax WiFi Endpoint SW: MAC: 30:1f:9a:70:01:d2 S/N: 383200012018080116	Ethernet link: WiFi Rx/Tx: 0/0 kB/s Ethernet Rx/Tx: 0/0 kB/s G.hn Rx/Tx: 0/0 kB/s	EoC out: 2 Rx/Tx: 0/0 Mbps	Reset
EPC_011e	offline	Guest only	Model: EoC Coax WiFi Endpoint SW: MAC: 30:1f:9a:70:01:1e S/N: 383200012018080071	Ethernet link: WiFi Rx/Tx: 0/0 kB/s Ethernet Rx/Tx: 0/0 kB/s G.hn Rx/Tx: 0/0 kB/s	EoC out: 1 Rx/Tx: 0/0 Mbps	Reset
EPC_0e16	OK	Guest only	Model: EoC Coax WiFi Endpoint SW: 2.1.3.r53	Ethernet link: Not connected WiFi Rx/Tx: 0/0 kB/s	EoC out: 2 Rx/Tx: 1710/1660 Mbps	Reset

When showing the Endpoint status, the model, SW version, MAC address, and serial number (S/N); is visible.

The group that the particular endpoint belongs to, is shown, as well as the network usage.

When status "OK" – endpoint can be reset via the GUI.



## Network

Change settings of the network infrastructure, including the coax data connection.

### NETWORK SETTINGS

Management settings
Remote access
VLAN settings
WiFi settings
Ethernet settings
G.hn settings
Group settings
Endpoints

## Management settings

Apart from the default controller setup interface on ethernet port 1 (setup VLAN 10), it is possible here to allow management access through an additional VLAN (ethernet port) of your choice. Furthermore, you can configure IPv4 settings used for management.

## Remote access

This enables remote access, to the controller and to the endpoints (through the controller).











This is for TRIAX support **only**. It is mentioned here for informative means.

## VLAN settings

Set the VLAN and client isolation, used in the system. The standard configuration for the controller, is as follows:

- Ethernet port 1: Fixed for setup port (VLAN 10).
- Ethernet port 2: Private network (VLAN 50).
- Ethernet port 3: Guest network (VLAN 100).
- Ethernet port 4: IP TV (VLAN 80).

VLAN settings

Name	VLAN	Client isolation	Edit	Save	Remove
Guest	100	<input checked="" type="checkbox"/>			
IP TV	80	No isolation			
Private	50	No isolation			
Setup	10	No isolation			

### WiFi settings

Set the WiFi region, band and encryption.

Disable band and client steering

Region Denmark

SSID	SSID Broadcast	2.4 GHz	5 GHz	VLAN	Encryption	Cipher	Edit	Save	Remove
<span style="border: 1px solid #ccc; padding: 2px;">Guest</span>	<input checked="" type="checkbox"/>	<input checked="" type="checkbox"/>	<input checked="" type="checkbox"/>	<span style="border: 1px solid #ccc; padding: 2px;">Guest (100)</span>	WPA2 Personal Key: <span style="border: 1px solid #ccc; padding: 2px;">guestpassphrase</span>	<span style="border: 1px solid #ccc; padding: 2px;">auto</span>			
Private	Enabled	Enabled	Enabled	Private (50)	WPA2 Personal	auto			
TriaxSetup_aeee	Enabled	Enabled	Enabled	Setup (10)	WPA2 Personal	auto			

### Ethernet settings

Set the ethernet settings for the controller and endpoints.

Controller

Ethernet port	VLAN pass-through	Access VLAN	Trunk VLANs	Edit	Save
1	Disabled	Setup (10)	All		
2	<input type="checkbox"/>	<span style="border: 1px solid #ccc; padding: 2px;">Private (50)</span> <small>None Guest (100) IP TV (80) Private (50) Setup (10)</small>	<span style="border: 1px solid #ccc; padding: 2px;">None</span>		
3	Disabled		None		
4	Enabled	Used internally	Automatic forwarding of all VLANs		

The "Endpoints" table holds two pre-configured and immutable rules: "Setup" and "Pass-through".

- The "Setup" rule can be used to make an endpoint port function just as port 1 on the controller i.e. the port can be used for configuration of the entire EoC system.
- The "Pass-through" rule must be applied to any port that is converted from an ordinary port servicing user-traffic to a port that extends the EoC system itself.

Endpoints

Rule name	Access VLAN	Trunk VLANs	DHCP server on ethernet port	Edit	Save	Remove
<span style="border: 1px solid #ccc; padding: 2px;">Guest</span>	<span style="border: 1px solid #ccc; padding: 2px;">Guest (100)</span>	<span style="border: 1px solid #ccc; padding: 2px;">None</span> <small>None All Only None</small>	<input type="checkbox"/>			
IP TV	IP TV (80)		Block			
Pass-through	Used internally	Automatic forwarding of all VLANs	Block			
Private	Private (50)	None	Block			
Setup	Setup (10)	None	Block			

### G.hn settings - combining

EoC out ports can be combined with each other, to facilitate from 17 to 64 Endpoints on a single COAX line. This can be configured by enabling a 'combining group', as shown in the table below. It is then possible to choose between 2 and 4 EoC out ports to be combined. Each EoC out port facilitates from 1 to 16 Endpoints.

G.hn combining

Group	EoC Ports	Enabled
A	EoC out #1 <input checked="" type="checkbox"/> EoC out #2 <input checked="" type="checkbox"/> EoC out #3 <input type="checkbox"/> EoC out #4 <input type="checkbox"/>	<input checked="" type="checkbox"/>
B	EoC out #1 <input type="checkbox"/> EoC out #2 <input type="checkbox"/> EoC out #3 <input checked="" type="checkbox"/> EoC out #4 <input checked="" type="checkbox"/>	<input checked="" type="checkbox"/>

Set G.hn groups

### G.hn settings - multicast

Multicast configuration

Multicast snooping:

Broadcast IGMP allowed:

Filter unknown multicast traffic:

IGMP Multicast ranges configuration

Minimum IP address				Maximum IP address			
<input type="text" value="224"/>	<input type="text" value="0"/>	<input type="text" value="0"/>	<input type="text" value="0"/>	<input type="text" value="224"/>	<input type="text" value="254"/>	<input type="text" value="255"/>	<input type="text" value="255"/>
<input type="text"/>	<input type="text"/>	<input type="text"/>	<input type="text"/>	<input type="text"/>	<input type="text"/>	<input type="text"/>	<input type="text"/>
<input type="text"/>	<input type="text"/>	<input type="text"/>	<input type="text"/>	<input type="text"/>	<input type="text"/>	<input type="text"/>	<input type="text"/>
<input type="text"/>	<input type="text"/>	<input type="text"/>	<input type="text"/>	<input type="text"/>	<input type="text"/>	<input type="text"/>	<input type="text"/>

Set IGMP ranges

### G.hn settings – notch filter

G.hn uses the 0...200MHz range, but in case a sub band is used for another purpose, eg. a FM radio; a notch filter can be configured, to exclude the sub band from the G.hn range.

This is however no problem, as the controller and endpoints ignore frequencies if a notch filter is implemented. The datarate is reduced approximately with 8Mbps per. 1MHz bandwidth removed from the G.hn range.

A notch filter is essentially a band stop filter. The notch filter bandwidth is at -3dB attenuation from f1 to f2. It is only possible to create a notch filter in the G.hn range (0...200MHz).

Attenuation values can be within 1...41dB and 100dB for shutting off the G.hn.

Default built-in filter for FM is 84,5...111MHz / 100dB.

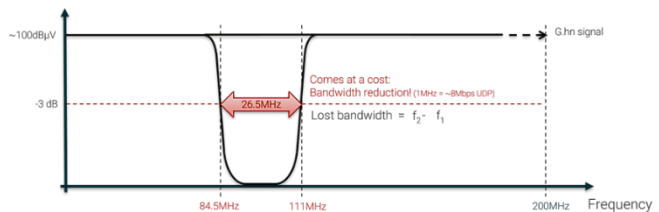

To achieve the -3dB attenuation it is vital to deduct 3-4 MHz from f1, and to add the same extra to f2.

In the example: f1=84,5MHz and not 87MHz and f2=111MHz and not 108MHz.

There is no notch filter integrated into the RP filter. The RP filter is a passive component, and is not related to the notch filters.

G.hn Notch Filters

^ Name	^ Start Freq (kHz)	^ Stop Freq (kHz)	^ Depth (dB)	Enable	Edit	Save	Remove
FM radio	84500	111000	100	No			

Add new notch filter

**Group settings**

The EoC controller comes with standard configuration groups. These can be used if you do not need any further WiFi SSIDs or configuration of ethernet ports.

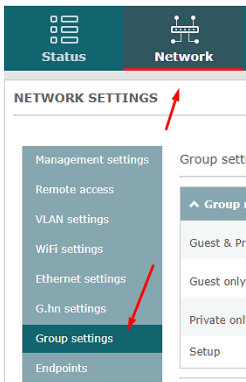

**The standard configuration can be used in any network where there is a need for**

- A private network, where clients must be able to communicate with each other. This could be printing from a PC to a network printer or a PC needs to get files from a local server etc.
- A public guest network, where clients cannot see each other (client isolation active). This allows for a public WiFi, where guests cannot access others devices in the EoC system.
- IP TV distribution.

**The standard configuration on the controller is as follows**

- Ethernet port 1: Fixed for setup port (VLAN 10).
- Ethernet port 2: Private network (VLAN 50).
- Ethernet port 3: Guest network (VLAN 100).
- Ethernet port 4: IP TV (VLAN 80).

^ Group name	^ WiFi SSIDs	^ Ethernet rule	Edit	Save	Remove
Guest & Private	Guest; Private.	IP TV			
Guest only	Guest.	IP TV			
Private only	Private.	IP TV			
Setup	TriaxSetup_of40.	Setup			

**Setup**

This is a group that is used only for initial setup of the endpoint. All new endpoints will by default be configured with this group. An endpoint in this group broadcasts the **TriaxSetup\_XXXX** WiFi SSID, which allows you to connect to the controller to configure an endpoint.

It sets the endpoint up as follows:

- VLAN 10 on ethernet port.
- SSID: **TriaxSetup\_XXXX** (VLAN 10).

**Guest only**

This is a group for a public guest network. It sets up the endpoint as follows:

- VLAN 80 on ethernet port (intended for IP TV – but basically a private VLAN).
- SSID: Guest (VLAN 100, with client isolation).

**Private only**

This is a group for a private VLAN. It sets up the endpoint as follows:

- VLAN 80 on ethernet port (intended for IP TV – but basically a private VLAN).
- SSID: Private (VLAN 50).

**Guest and Private**

This is used for an endpoint which serves both private and public WiFi. It sets up the endpoint as follows:

- VLAN 80 on ethernet port (intended for IP TV – but basically a private VLAN).
- SSID: Private (VLAN 50).
- SSID: Guest (VLAN 100, with client isolation).

To edit a group, press “Edit”:

Group settings

Group name	WiFi SSIDs	Ethernet rule	Edit	Save	Remove																		
<input type="text" value="Guest &amp; Private"/>	<table border="1"> <tr> <td>Guest</td> <td>⊙</td> </tr> <tr> <td>Private</td> <td>⊙</td> </tr> <tr> <td>Guest</td> <td> <input type="button" value="Add"/> </td> </tr> </table>	Guest	⊙	Private	⊙	Guest	<input type="button" value="Add"/>	<table border="1"> <tr> <td>IP TV</td> <td>▼</td> </tr> <tr> <td>Guest</td> <td></td> </tr> <tr> <td>IP TV</td> <td></td> </tr> <tr> <td>Pass-through</td> <td></td> </tr> <tr> <td>Private</td> <td></td> </tr> <tr> <td>Setup</td> <td></td> </tr> </table>	IP TV	▼	Guest		IP TV		Pass-through		Private		Setup				
Guest	⊙																						
Private	⊙																						
Guest	<input type="button" value="Add"/>																						
IP TV	▼																						
Guest																							
IP TV																							
Pass-through																							
Private																							
Setup																							
Guest only	Guest.	IP TV																					
PassThrough	Guest.	Pass-through																					
Private only	Private.	IP TV																					
Setup	TriaxSetup_0001.	Setup																					

### Endpoints

It is possible to see all endpoints configured on the controller.

- Endpoints which has just been connected will get the configuration from the Setup group, which means that they will broadcast a WiFi SSID called **TriaxSetup\_xxxx** and the ethernet port can be used to connect to the controller GUI.
- For each WiFi endpoint it is possible to configure the 2.4 GHz / 5 GHz radio settings individually. This includes adjusting the transmit (Tx) power, WiFi channel and the channel width as well as what WiFi modes are allowed.



### System

System settings not related to network settings can be set here.

#### Date & time settings

You can choose to use the time servers already configured or add a new timeserver, if you wish to use a custom.

#### Account settings

This is where you can change the login for the controller interface.

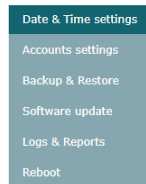

#### Backup & Restore

You can export the current configuration as a backup file. Backup files can also be imported, which will overwrite the current settings of the controller, and replace them with the settings in the backup file.

When setting up multiple controllers in multiple locations, you could duplicate the settings, by setting up one controller, exporting a backup and then import that backup to other controllers.

You also have the possibility to reset the controller to the factory default configuration.

Remember that this not only affects the controller as any connected endpoints will now get the default configuration as well.

#### Software update

This allows you to update the software used by the controller and endpoints. Any software applied to the controller will transfer to the endpoints.

When an EoC Endpoint starts the SW update process, it will be shown with status "Updating". During the update process it can temporarily have the status "Offline". **Do NOT** remove the power to the endpoint, until the status again is "OK". If the Endpoint is powered off during the update state, it will cease to function.

**Downgrade:** It is possible to downgrade to a minor SW version but NOT to a major SW version.  
 An example: from 2.5 to 2.4 – this is possible.  
                   from 3.0 to 2.9 – this is NOT possible.

**Logs & Reports**

Here you can export logs of what has happened in the system or export an equipment file showing all EoC equipment connected to the controller (including the controller).

**Reboot**

Manual reboot of the controller. No changes will be made to the configuration; the controller will shut down and boot back up.

**Performance**

In the performance page, you can choose an endpoint and start a TCP traffic test. The results are listed in a table, including up and download speeds.

**PERFORMANCE**

Endpoint

Results

Endpoint Name	RX min	RX max	RX avg	TX min	TX max	TX avg	Time
---------------	--------	--------	--------	--------	--------	--------	------

Be careful how to interpret the results! The test can't be used to validate the data rate throughput experienced by clients on WiFi or ethernet, as the data rate throughput available for the test is limited. Furthermore, any network data traffic (from other sources) can influence the results, as the coax medium and internal switching capabilities of the system are shared among devices. In case it is desired to validate the data rate throughput as experienced by clients, please use appropriate test equipment.

**10. Support & installation report**

To get support, registered users can access our support sites at:  
<https://www.comptel.com/b2buserregister>  
 If not a registered user, please create a login.

Support site is located at:  
<https://comptel.freshdesk.com/en/support/home>



The next pages shows a handy tool – the installation report. Whenever a new EPE, EPC or EMC is installed, take the enclosed label, fix it at the installation, report along with location information, installation site, installer name and date.

Installation report



Location:

---



Location:

---

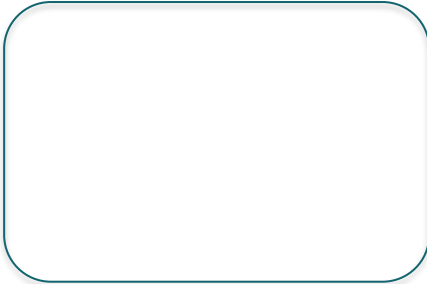

Location:

---

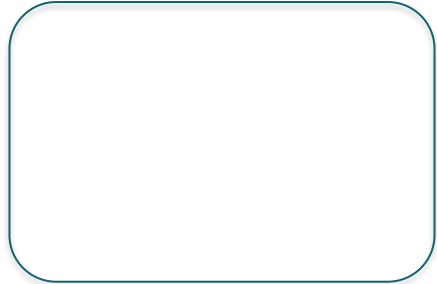

Location:

---



Location:

---



Location:

---

Place/address of installation:

Installer:

Date:



Installation report



Location:

---

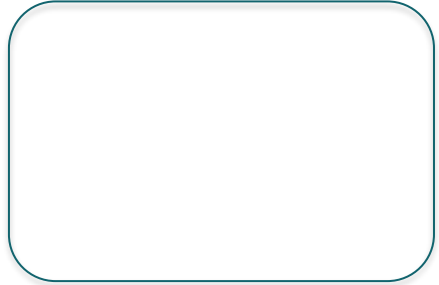

Location:

---



Location:

---

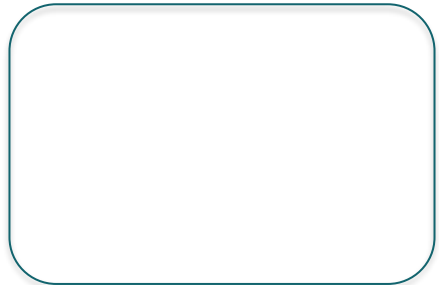

Location:

---



Location:

---



Location:

---

Place/address of installation:

Installer:

Date:

Installation report



Location:

---



Location:

---



Location:

---



Location:

---

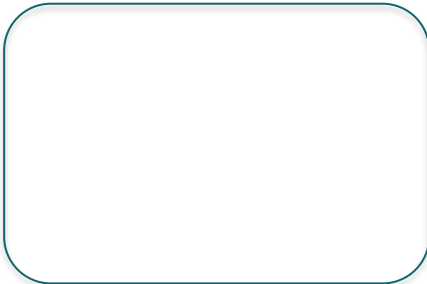

Location:

---

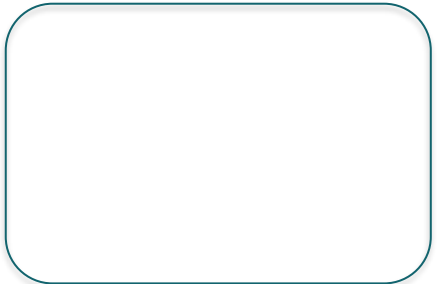

Location:

---

Place/address of installation:

Installer:

Date:

Installation report



Location:

---



Location:

---



Location:

---



Location:

---



Location:

---



Location:

---

Place/address of installation:

Installer:

Date:



## Information and manuals:

Information og brugervejledninger:  
Information och manualer:  
Information und Bedienungsanleitungen:  
Informations et modes d'emploi:  
Información y manuales:  
Lisätietoja ja oppaita:  
információk és útmutatók:

[triax.com](https://www.triax.com)

[triax.dk](https://www.triax.dk) - [triax.se](https://www.triax.se) - [triax-gmbh.de](https://www.triax-gmbh.de) - [triax.fr](https://www.triax.fr) -  
[triaxmultimedia.es](https://www.triaxmultimedia.es) - [triax.uk](https://www.triax.uk)  
[triax.at](https://www.triax.at) – [triax.hu](https://www.triax.hu)

Subject to change without notice  
Änderungen vorbehalten  
Peut être sujet à modification sans préavis



Copyright © 2020 TRIAX. All rights reserved.  
The TRIAX Logo and TRIAX Multimedia are registered trademark(s) of the  
TRIAX Company or its affiliates.

TRIAX A/S | Bjørnkærvej 3 | 8783 Hornsyld | Denmark

[triax.com](https://www.triax.com)