

www.kdelectronics.ie

PRODUCT Catalogue

2022

IP CCTV | HDCVI | ACCESS CONTROL | VIDEO INTERCOM | GATE AUTOMATION |
INTRUDER ALARMS | DATA CABINETS | NETWORKING | DISPLAY | ACCESSORIES

TABLE OF CONTENTS

| | | | |
|--------------------------------|-----|--|--|
| INTRODUCTION | | | |
| KD Electronics overview | 3 | | |
| KD's partners | 4 | | |
| Integrator Training Programme | 6 | | |
| DAHUA AI TECHNOLOGY | | | |
| What is WizMind? | 7 | | |
| What is WizSense? | 8 | | |
| DAHUA NAMING RULE | | | |
| Naming rule | 9 | | |
| WIZMIND SERIES | | | |
| Panoramic Series | 16 | | |
| 8 Series | 19 | | |
| 7 Series | 20 | | |
| 5 Series | 22 | | |
| WIZSENSE SERIES | | | |
| 3 Series - TiOC | 25 | | |
| IP CAMERAS | | | |
| Lite Series | 32 | | |
| Special Series | 35 | | |
| ANPR | 36 | | |
| IP PTZ CAMERAS | | | |
| Wizmind Series | 37 | | |
| Wizsense Series | 38 | | |
| Lite Series | 41 | | |
| THERMAL CAMERAS | | | |
| Thermal Cameras | 42 | | |
| NVRs | | | |
| Wizmind Series | 44 | | |
| Wizsense Series | 45 | | |
| Ultra Series | 45 | | |
| Pro Series | 46 | | |
| Lite Series | 47 | | |
| DAHUA HDCVI CAMERAS | | | |
| Active Deterrence - TiOC | 50 | | |
| Pro Series | 51 | | |
| Lite Series | 53 | | |
| PoC Series | 59 | | |
| Micro Size | 61 | | |
| DAHUA HDCVI PTZ CAMERAS | | | |
| PTZ Cameras | 62 | | |
| DAHUA XVRs | | | |
| Wizsense Series | 63 | | |
| PoC Series | 67 | | |
| EZ SERIES | | | |
| EZ-IP | 69 | | |
| EZ Cooper | 70 | | |
| DAHUA DISPLAYS | | | |
| Monitors | 72 | | |
| Display solutions | 74 | | |
| DAHUA TRANSMISSION | | | |
| Switches | 77 | | |
| SUPREMA ACCESS CONTROL | | | |
| RF/Mobile readers | 84 | | |
| Biometric readers | 88 | | |
| Controller | 95 | | |
| Peripherals | 96 | | |
| Kits | 97 | | |
| Platform | 98 | | |
| DAHUA ACCESS CONTROL | | | |
| AI Standalone | 100 | | |
| Standalone | 103 | | |
| Readers | 104 | | |
| Controllers | 105 | | |
| Time Attendance | 106 | | |
| STP ACCESSORIES | | | |
| Exit buttons | 107 | | |
| Break glass units | 107 | | |
| Maglocks | 108 | | |
| Power Supplies | 109 | | |
| DAHUA VIDEO INTERCOM | | | |
| IP Outdoor Stations | 111 | | |
| IP Indoor Monitors | 114 | | |
| 2-wire Series | 115 | | |
| Kits | 115 | | |
| Video Doorbell | 116 | | |
| GATE AUTOMATION | | | |
| DEA Overview | 118 | | |
| Swinging Gates | 124 | | |
| Sliding Gates | 132 | | |
| Barriers | 136 | | |
| Accessories | 140 | | |
| INTRUDER ALARMS | | | |
| Texecom Overview | 147 | | |
| Alarm kits | 148 | | |
| Keypads | 149 | | |
| Panels | 150 | | |
| Wired PIRs | 151 | | |
| Wired sensors & contacts | 152 | | |
| Extra wired devices | 154 | | |
| Wireless PIRs | 155 | | |
| Wireless sensors & contacts | 156 | | |
| Extra wireless devices | 158 | | |
| Sounders | 159 | | |
| Diallers & communicators | 160 | | |
| Expanders | 161 | | |
| Accessories | 162 | | |
| FORMRACK DATA CABINETS | | | |
| 19" Wall Mounted | 164 | | |
| 19" Free Standing | 165 | | |
| Accessories | 166 | | |
| ACCESSORIES | | | |
| Cables & Connectors | 168 | | |
| Wireless transmission | 169 | | |
| Network accessories | 169 | | |
| A/V Extenders | 170 | | |
| Baluns & PSU | 171 | | |
| CCTV accessories | 172 | | |

About us

KD Electronics are wholesale distributors to the Trade of TV, Satellite, CCTV, Video intercom, Access control, Alarm, Fire detection, Audio, Gate automation and Network products Since 1994.

We have been working closely with our customers for over 25 years planning IRS systems, large CCTV projects, Audio Systems and much more to the highest standards.

We now have two trade counters in our warehouse in Cork and Dublin. We offer next day delivery with DPD, Eco Express or Fastway. Credit and cash customers can register on our website and place orders through our online store or through our mobile application on credit or pay online via multiple payment methods.

You can register for a Trade account now to view our trade prices and live stock with next day delivery when you place an order before 3:30pm.

If you are interested in being a reseller or if you are a wholesaler we can set you up on our special reseller pricing structure just email us at sales@kdelectronics.ie.

Check out the full range of products on our website www.kdelectronics.ie or mobile application where you can order, view live prices and data-sheets.

Our services



Training Days

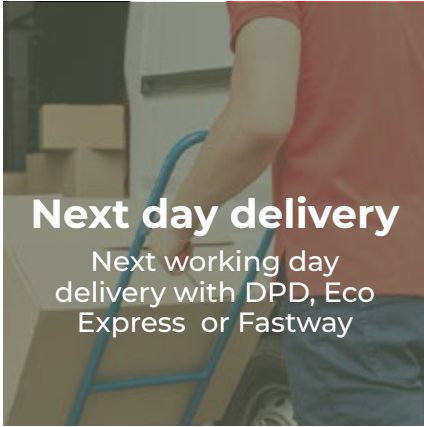

Next day delivery

Next working day delivery with DPD, Eco Express or Fastway



Technical Support



Newsletter

Subscribe to our newsletter for monthly special offers and news on the latest technology & products

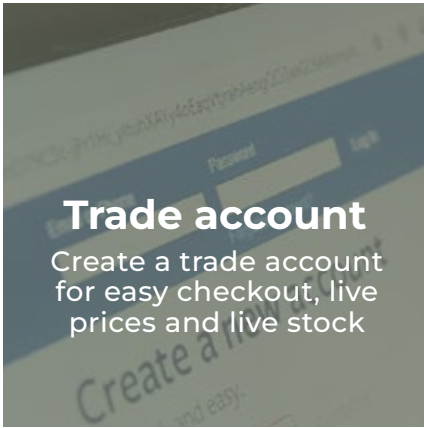

Trade account

Create a trade account for easy checkout, live prices and live stock



Mobile Application

Browse our full range of products and place your order from anywhere



CCTV - ACCESS CONTROL - VIDEO INTERCOM

Dahua Technology is a world-leading, video-centric smart IoT solutions and service provider, creating advanced security solutions for transportation, education, city surveillance, retail and commercial markets worldwide. The company's focus on technical innovation is reflected in over 10% of its annual turnover invested in R&D. Dahua Technology, which had total sales of USD 3.73 billion in 2019, has won many international awards and strives to be the security industry partner of choice. The company has distribution partners in over 180 countries.



GATE AUTOMATION

DEA Gate Automation create products and systems for the automation of buildings and public spaces able to interact in a simple and smart way with professionals and end users. The company was established in Italy in 1993. DEA's vision has always been multinational from the very beginning of its activities. They exported their challenge and values almost 30 years ago, becoming a company highly renowned and appreciated worldwide for its quality automation products. Since 2020, KD Electronics became an authorised DEA distributor. We stock and deliver across Ireland, automations for residential, collective and industrial gates.



ACCESS CONTROL

Suprema is a leading global provider of access control, time & attendance and biometrics solutions. By combining world renowned biometric algorithms with superior engineering, Suprema has introduced innovations to the security industry over the last decades. Suprema's extensive range of portfolio includes biometric access control systems, time & attendance solutions, fingerprint live scanners, mobile authentication solutions and embedded fingerprint modules. Suprema is named the world's top 50 security manufacturers and has a worldwide sales network in over 140 countries with no.1 market share in biometric access control in EMEA region.



INTRUDER ALARM

Texecom is Europe's largest independent security alarm specialist providing bespoke design solutions that protect people and property throughout the world. Texecom's award-winning products cover every aspect of external and internal security requirements, including a full range of motion detectors, control panels, perimeter protection devices, fire detectors and external sounders. Texecom launched a ground breaking wireless technology, Ricochet mesh networking, to universal acclaim. Texecom is leading the way with digital and cloud-based solutions, adding value and providing interoperability with wider security and building management systems – offering increasingly connected, intelligent and dynamic solutions to meet the world's future security challenges.

Milestones

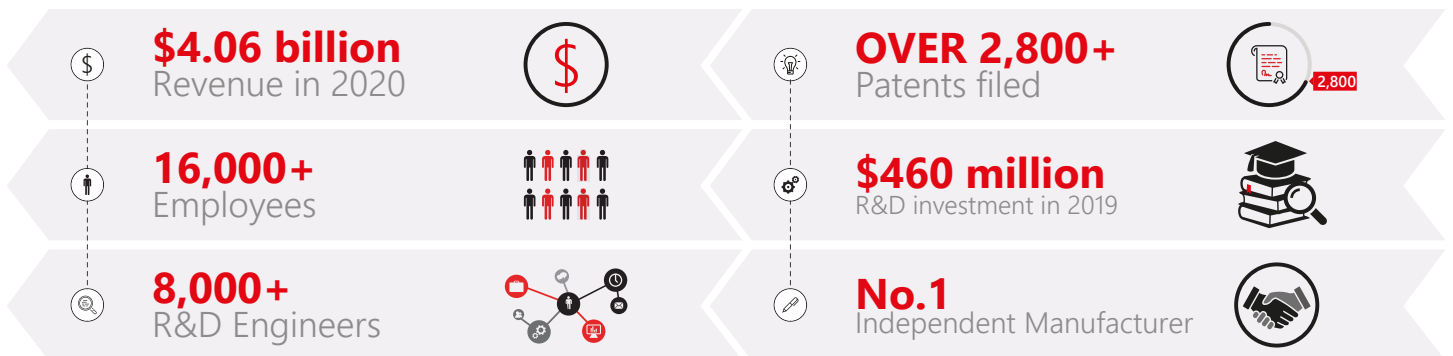

Overview



Dahua Technology is a world-leading video-centric smart IoT solution and service provider. Based on technological innovations, Dahua Technology offers end-to-end security solutions, systems, and services to create values for city operations, corporate management, and consumers.

With more than 16,000 employees and over 50% engaged in R&D, Dahua Technology has solutions, products, and services applied in 180 countries and regions. Since the launch of the industry's first self-developed 8-channel embedded DVR in 2002, Dahua Technology has devoted itself to technological innovation and been continuously increasing its investment in R&D, putting around 10% of its annual sales revenue into R&D. The company continues to explore emerging opportunities based on video IoT technologies and has already established business in machine vision, video conferencing systems, professional drones, electronic license plates, RFID, and robotics etc.

Moreover, Dahua Technology has established 53 overseas subsidiaries and representative offices covering the Asia Pacific, North America, Europe, Africa and other regions to provide customers with speedy and high-quality services. In addition, Dahua products are widely applied in key vertical markets such as public security, traffic, retail, banking & finance, and energy etc. Numerous major projects have been installed with Dahua solutions and products – China International Import Expo, the Rio Olympics, G20 Hangzhou Summit, BRICS Xiamen Summit, Lincoln City Surveillance in UK, Recife CBTU Subway in Brazil as well as many others.

Dahua Technology has applied for over 2,800 patents, including more than 150 international patents. Dahua Technology has been ranked 2nd for 5 years in a row in the global CCTV & video surveillance equipment market*, and has maintained its spot in the 2019 a&s Security 50, ranking 2nd for two consecutive years.



Partner with a multi-award winning company

Dahua Technology has won many international awards over the years and strives to be the security industry's partner of choice. When you partner with us, you gain access to the most advanced video surveillance equipment and software available, as well as the people who develop it.

Becoming part of the Dahua Integrator Training Programme will give you an additional competitive edge in the marketplace.

As part of our dedication to improving best practice in the CCTV sector, we run regular training and certification programmes to give installers and engineers the necessary skills to design and install the most appropriate video solutions. The courses provide a combination of theory and hands-on, practical training using state-of-the-art technology, enabling participants to develop the skills they need to deliver the best video solutions.

DHSA

VSS-DHSA | Video Surveillance System - Dahua Security Associate (VSS-DHSA)

VSS-DHSA was introduced in 2016 and has been running in the UK for more than two years with thousands of trained installers across the UK and Ireland. This course will help you to become an authorised Dahua installer.

THE TRAINING MODULES INCLUDE:

- Brief introduction to Dahua UK & Ireland
- Introduction to IP
- Introduction to main functions
- Product selection and system
- Remote Access
- Over half the course is hands-on training

DHSP

Video Surveillance System—Dahua Security Professional (VSS-DHSP)

VSS-DHSP was launched in September 2019 and is suitable for engineers, system integrators and security consultants who have already taken and passed the Video Surveillance System course—Dahua Security Associate (VSS-DHSA)

The course will enable you to take your learning one step further, enhancing your competitiveness in the marketplace and helping you to gain more knowledge about Dahua's advanced technology, including new AI technology

THE TRAINING MODULES INCLUDE:

- Brief introduction to Dahua UK & Ireland
- Introduction to IP
- Introduction to main functions
- Product selection and system
- Remote Access
- Over half the course is hands-on training

DHSE

Video Surveillance System - Dahua Security Expert (VSS-DHSE)

VSS-DHSE is our newly introduced training programme, launched in December 2019. This training programme is for all engineers, system integrators and security consultants who have already taken the Video Surveillance System - Dahua Security Professional (VSSDHSP). The course will allow you to take your learning one step further to enhance your competitiveness in the marketplace.

This course will help you to understand and gain knowledge about Dahua DSS (VMS Platform) and to know how to design a holistic surveillance solution.

THE TRAINING MODULES INCLUDE:

- Dahua DSS introduction
- DSS deploy & configure
- DSS basic functions
- DSS Artificial Intelligence

For more information about trainings and the different types of courses available please contact us at info@kdelectronics.ie

What is Wizmind?

Dahua Technology, with its award-winning deep-learning algorithms, proudly releases WizMind, a portfolio of solutions composed of project-oriented products including IPC, NVR, PTZ, XVR, thermal and software platform, delivering precise, reliable and comprehensive AI solutions to verticals including government, retail, energy, finance and transportation.

Human Applications

WizMind provides effective AI search to locate targets and generate human-based data for business analysis.



Thermal Applications

WizMind offers ultra-long range surveillance even in harsh environments. It is equipped with intelligent functions such as boat detection and early fire detection.



Vehicle Applications

WizMind supports more attributes of vehicles for easy management and control, quick search and efficient business analysis.



WizMind Ecosystem

The Dahua WizMind series is compatible with major third party platforms. Its WizMind Ecosystem provides sufficient DHOP and API, enabling excellent integration with our technology partners.

01 HUMAN APPLICATIONS

- Face recognition 2.0
- Privacy protection 2.0
- Human video metadata 2.0
- Wide area security 2.0
- People counting
- Heat Map
- Stereo analysis
- Smart tracking

02 VEHICLE APPLICATIONS

- Vehicle Video Metadata 2.0
- Illegal Parking Detection 2.0
- Parking Space Management
- ANPR

03 THERMAL APPLICATIONS

- Boat Detection
- Long Range Surveillance
- Temperature Measurement
- Fire Detection

What is Wizsense?

Launched by Dahua Technology, WizSense is a series of wide range AI products and solutions that adopt independent AI chip and deep learning algorithm. It can recognize human and vehicle in an image with high accuracy, enabling users to focus on real targets. Based on Dahua's advanced technology, WizSense makes your video intelligent, simple and inclusive.

Empowered by deep learning, WizSense provides full protection for customers' property and improves working efficiency before, during and after an event happens.

WizSense

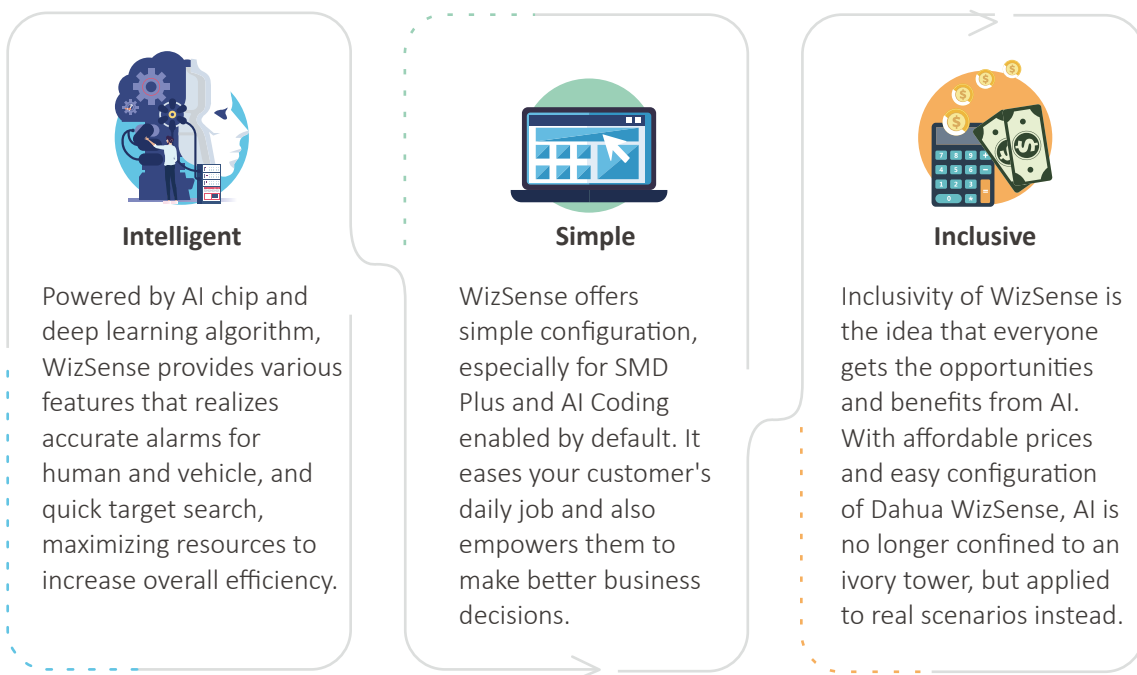

Accurate Prediction before Events

- SMD
- Perimeter protection
- Face Detection
- Face Recognition

Storage Saving while Ensuring the Image Quality of Target

- AI Coding

Protects Network Security and Prevents Privacy Disclosure

Instant Response during an Event

- Active Deterrence
- Time Sharing Monitoring
- Two-way Talk & Customizable Alert Voice Audio
- One Click Arming & Disarming

Quick Target Search after an Event

- SMD
- Perimeter protection
- Face Search

Network Camera

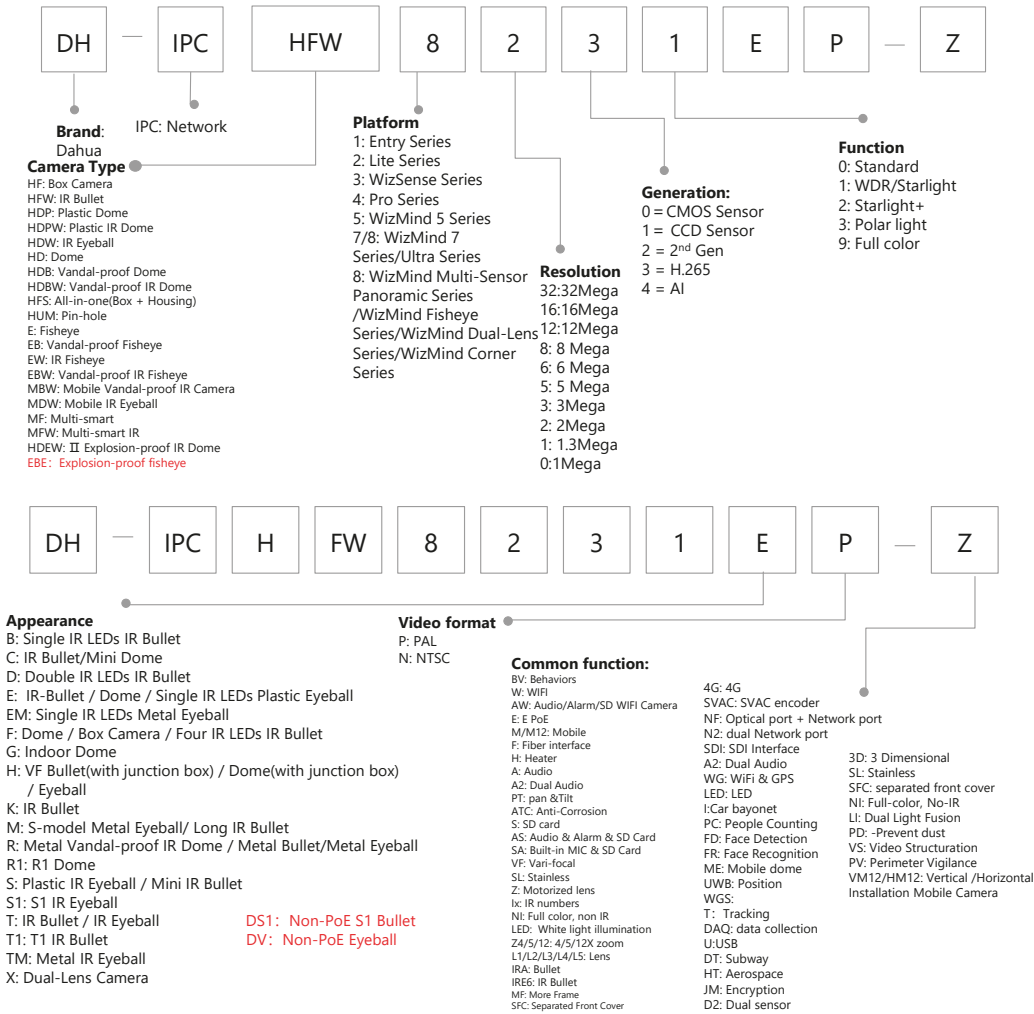

Network Camera (Panoramic Series)

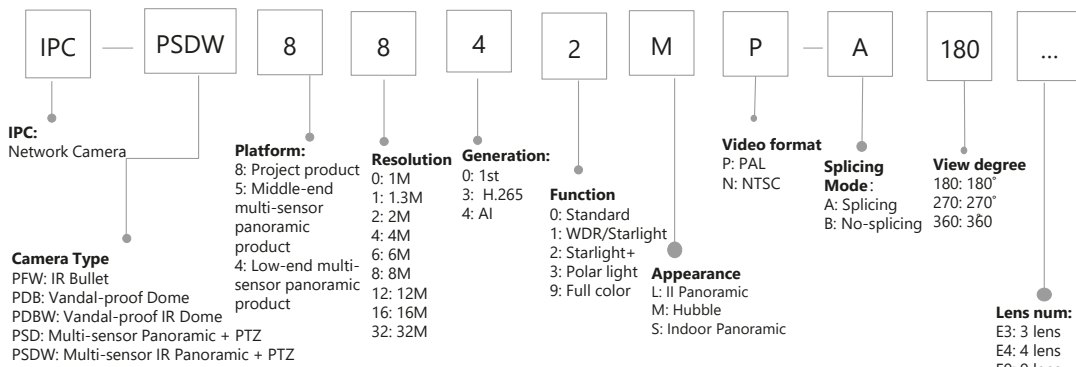

Network Camera (EZ-IP Series)

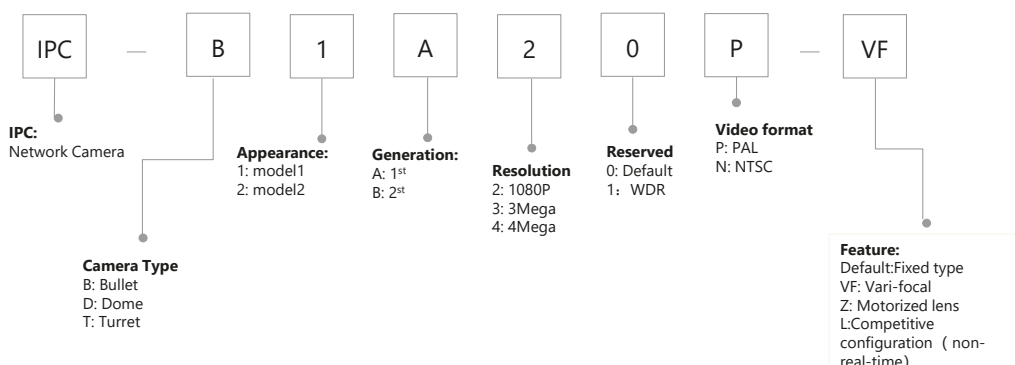

Speed Dome(Non-AI + Some AI Product)

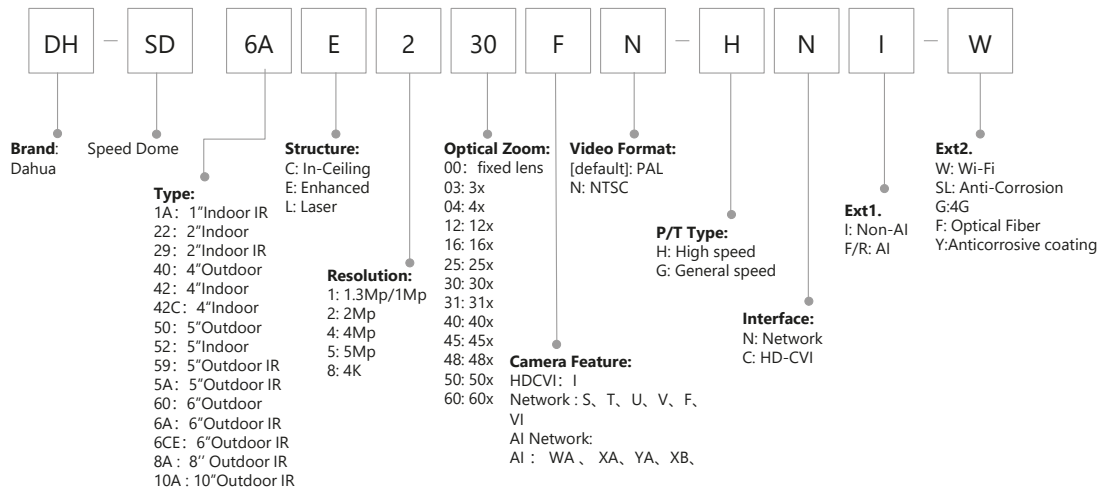

Speed Dome (AI Product) /PTZ(AI Product)/CVI Speed Dome

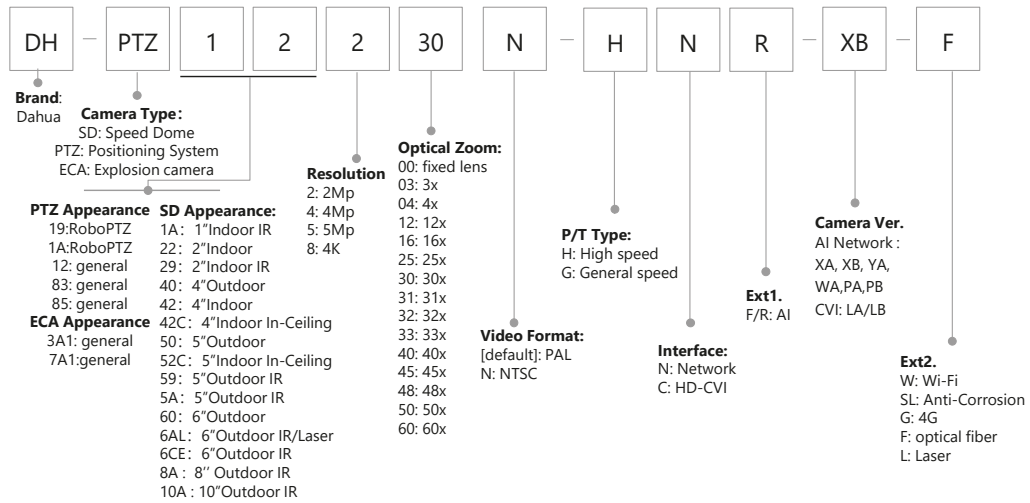

Thermal Camera

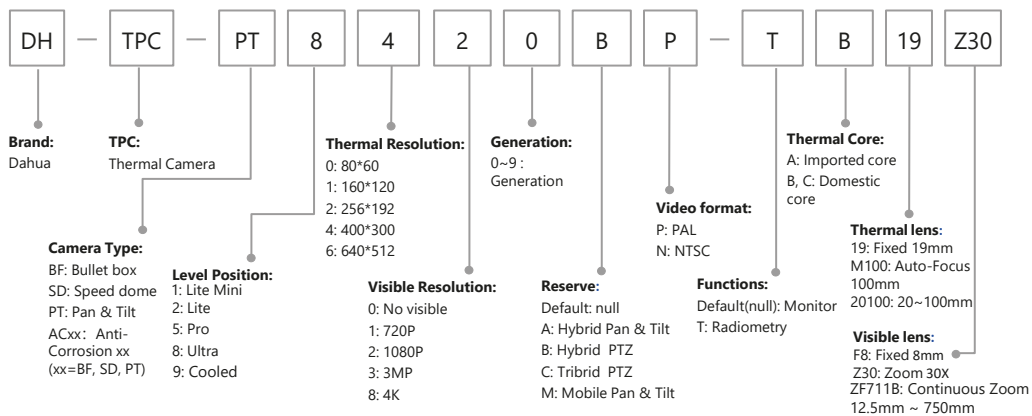

IVSS

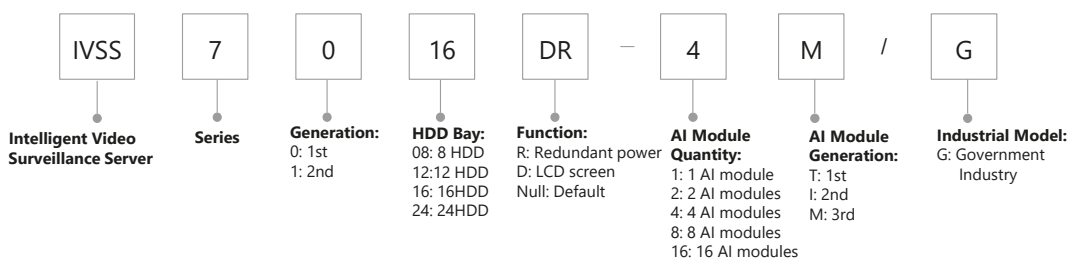

General NVR

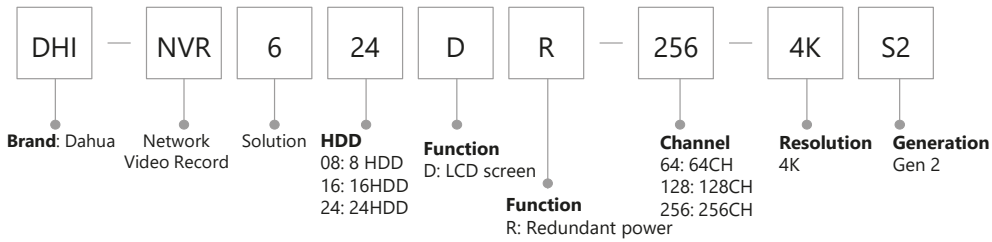
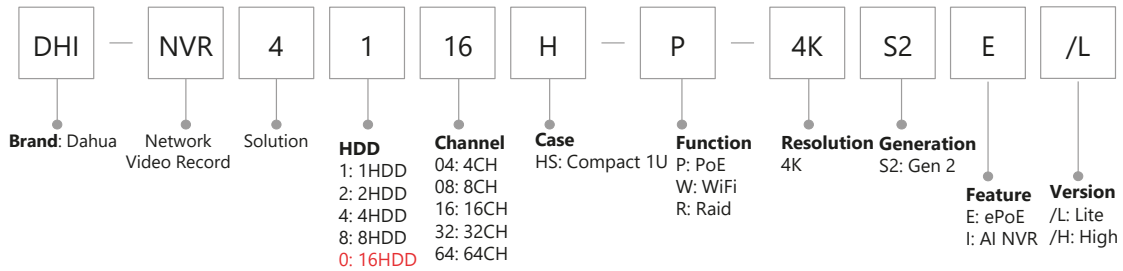

HDCVI Camera

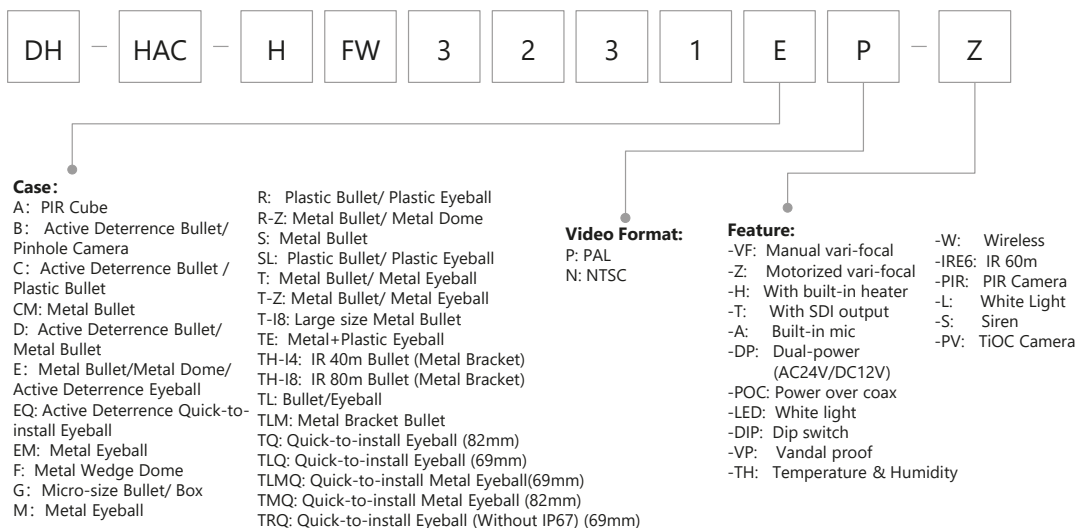
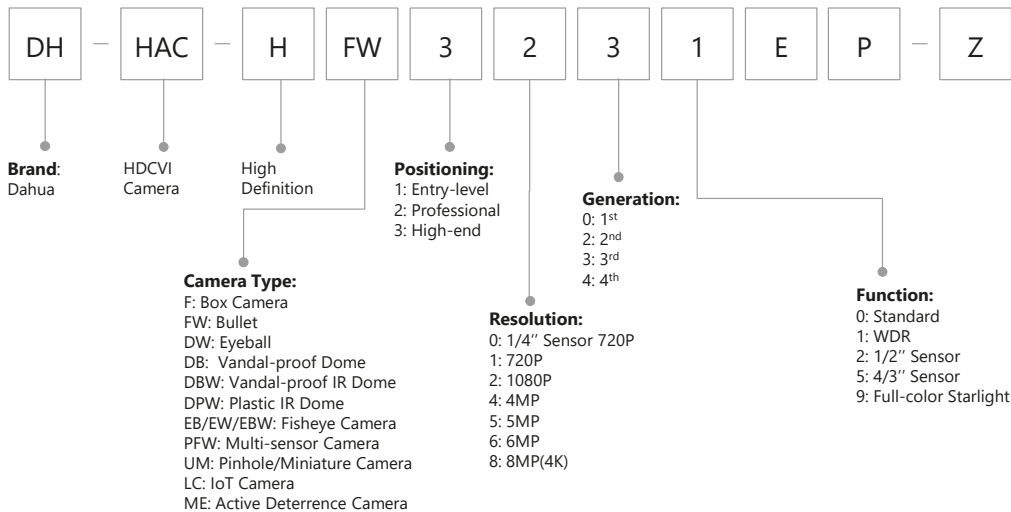

HDCVI Recorder (XVR)

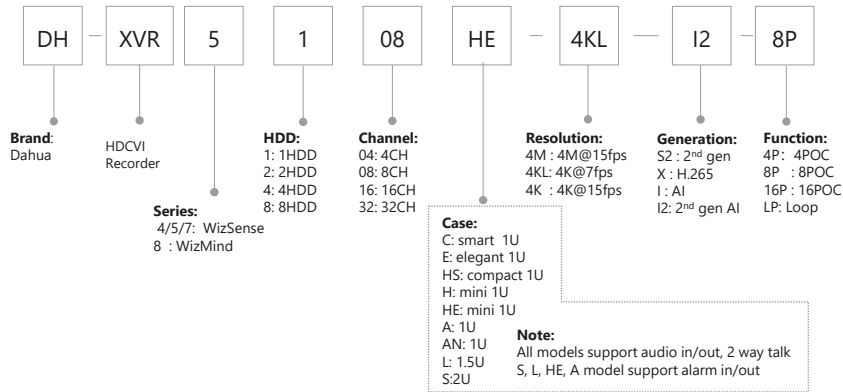

HDCVI Cooper Series (Camera & Recorder)

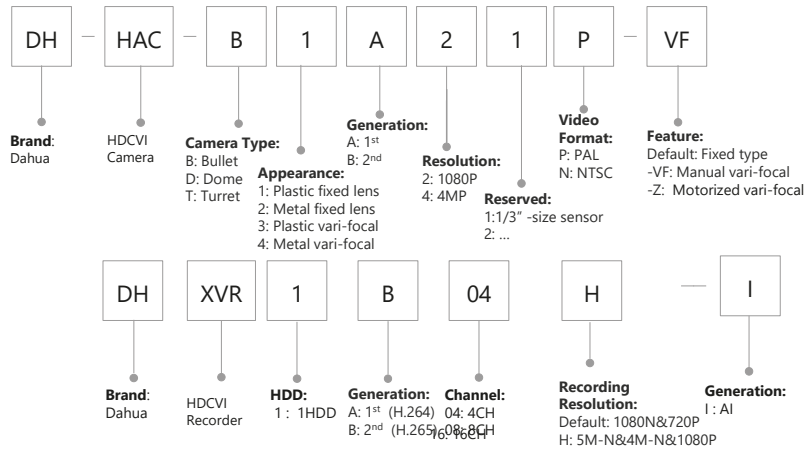

Monitor

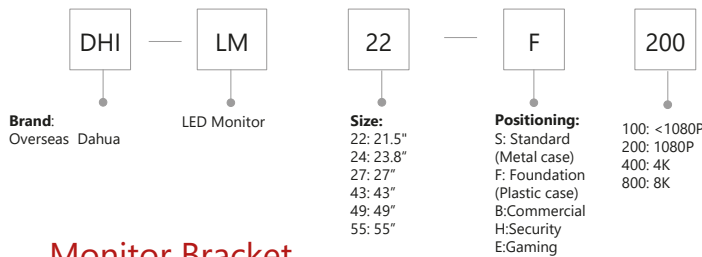

Monitor Bracket

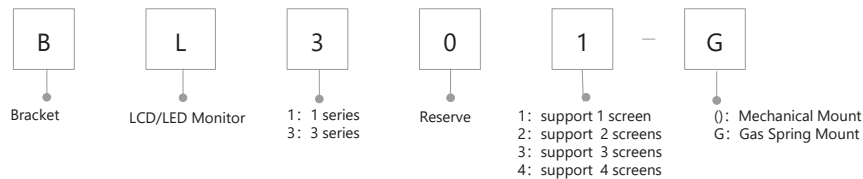

Switch

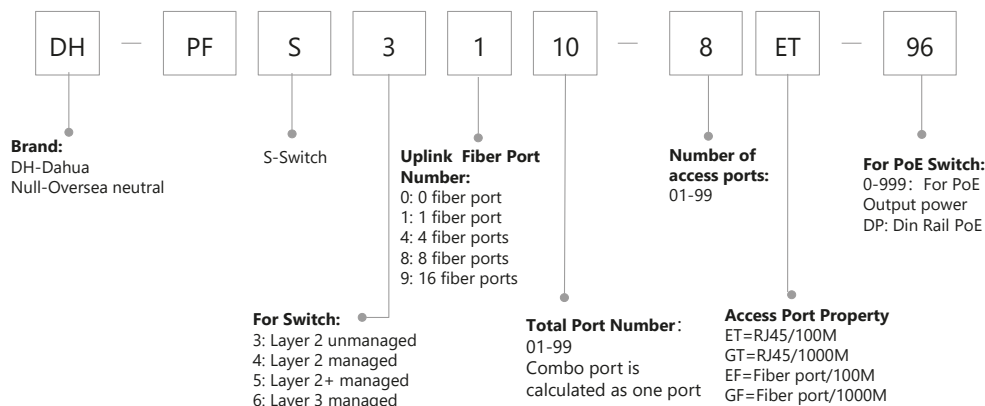

Video Intercom (Outdoor Station)

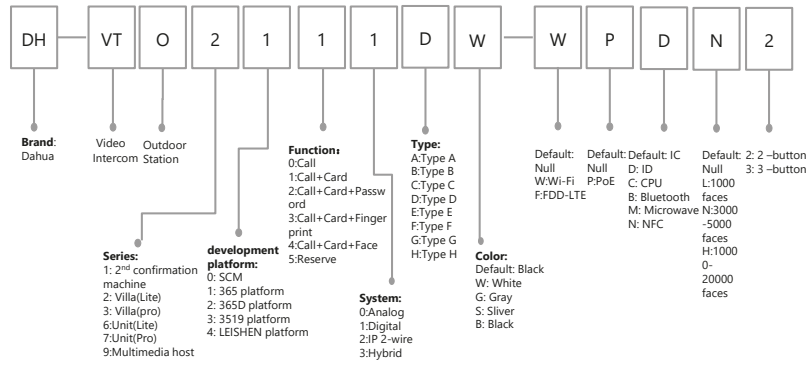

Video Intercom (Indoor Monitor)

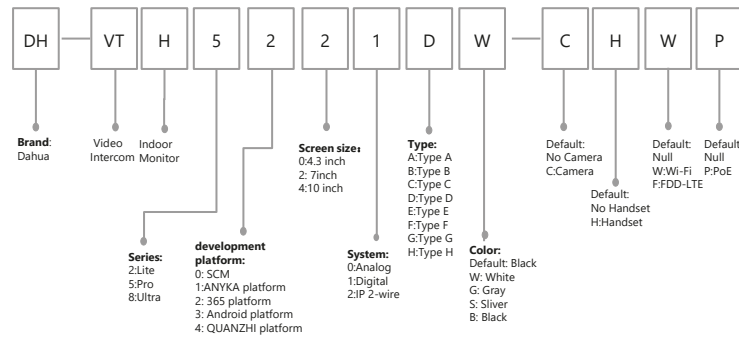

Access Control (Reader)

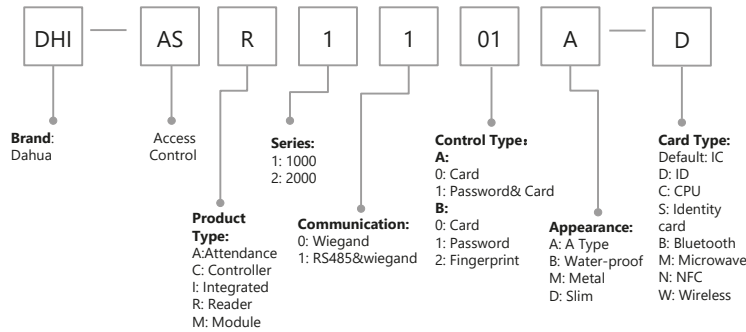

Access Control (Controller)

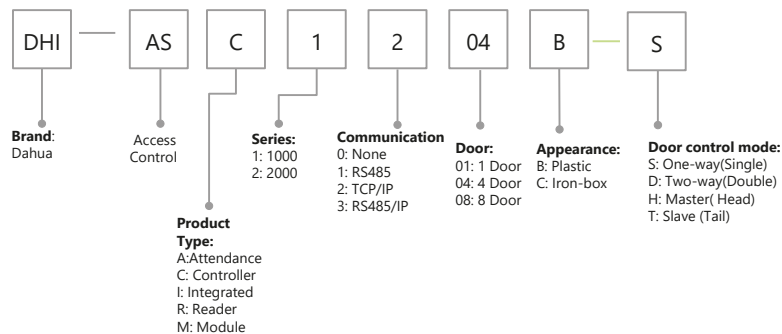

Access Control (Integrated/Attendance)

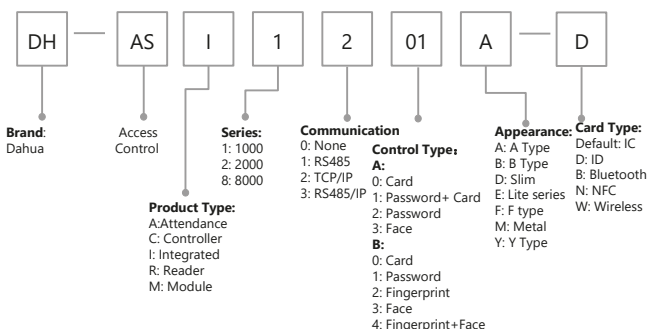

Access Control (Module)

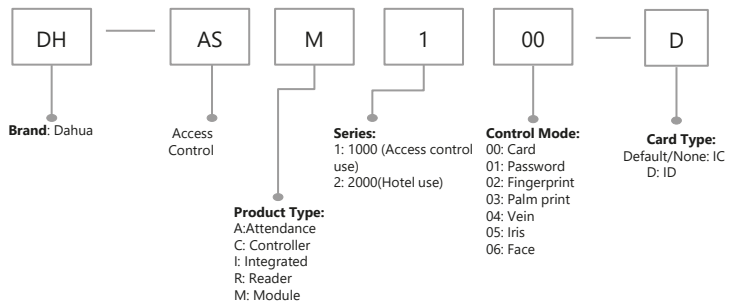



IP Cameras & NVRs

WIZMIND | TiOC | WIZSENSE | LITE SERIES | PRO SERIES | SPECIAL SERIES |
ANPR | PTZ | THERMAL | NVR

Standard camera



Starlight camera



Full-colour camera



DISCOVER THE BENEFITS OF

FULL COLOUR

More vivid, brighter and detailed images under low light conditions.



Dahua Technology's full-color camera captures vivid color information even in low-light conditions. It effectively extracts the color features of scenes – be it human, vehicle or details – in places with high crime rate such as a park at night or a dark alley, providing great help to police officers during the evidence obtaining procedure. In addition, the full-color camera also works with AI functions to further enhance the probability and accuracy of target recognition and feature extraction.

Suitable applications:



Car Parks



Urban Areas



Schools



Museums



Bars



Casinos

24/7 Colorful monitoring

- Presents colored images and captures vivid detail in low light conditions.
- Significantly increases probability of collecting valid human, vehicle, and event evidence through brighter monitoring

Excellent video quality in darkness

- Provides warm and smart auxiliary light to guarantee image clarity even in total darkness.
- Prevents rain reflection and does not attract insects.

Up to 98% AI accuracy at night

- Supports integration with recorder to achieve AI search and improve retrieval efficiency.
- Filters false alarms and allows human and vehicle classification to focus only on target of interest.

- ✓ **4x** the brightness of a standard camera
- ✓ **2.5x** the brightness of a Starlight camera

Multi Sensor



Our code:
11461

6x4MP: PSDW82442M-A270-D440

Multi-Sensor Panoramic Network Camera+PTZ Camera

- Panoramic network camera: Six 1/1.8"4Megapixel progressive CMOS
- PTZ camera: One 1/1.8"4Megapixel progressive CMOS
- Support 270-degree panoramic view
- Starlight+ technology
- Support Smart H265+/H264+ encoding
- Day/Night (ICR); 3D NR; AWB; AGC; BLC
- IR distance up to 400 m
- Smart tracking
- Tripwire
- Intrusion
- Crowd map
- Vehicle Density



Our code:
11460

4x4MP: PSDW81642M-A180-D440

Multi-Sensor Panoramic Network Camera+PTZ Camera

- Panoramic network camera: Four 1/1.8"4Megapixel progressive CMOS
- Support 180-degree panoramic view
- Starlight+ technology
- Support Smart H265+/H264+ encoding
- Day/Night (ICR); 3D NR; AWB; AGC; BLC
- IR distance up to 400 m
- Smart tracking
- Tripwire
- Intrusion
- Crowd map
- Vehicle density



Our code:
11401

8x2MP: PSDW81642M-A360

Multi-Sensor Panoramic Network Camera+PTZ Camera

- Panoramic camera: Eight 1/1.8" 2 Megapixel progressive scan CMOS
- PTZ camera: One 1/1.8" 4 Megapixel progressive scan CMOS
- Support 360-degree panoramic view
- Starlight+ technology
- Support Smart H265+/H264+ encoding
- Day/Night (ICR); 3D NR; AWB; AGC; BLC
- IR distance up to 400 m
- Smart tracking
- Tripwire
- Intrusion
- Crowd map



Multi Sensor



Our code:
11418

4x2MP: PSDW8842M-A180

Multi-Sensor Panoramic Network Camera+PTZ Camera

- Panoramic camera: Four 1/1.8" 2 Megapixel progressive scan CMOS
- PTZ camera: One 1/1.8" 4 Megapixel progressive scan CMOS
- Support 180-degree panoramic view
- Starlight+ technology
- Support Smart H265+/H264+ encoding
- Day/Night (ICR); 3D NR; AWB; AGC; BLC
- IR distance up to 400 m
- Smart tracking
- Tripwire
- Intrusion
- Crowd map



Our code:
11462

4x5MP: IPC-PDBW82041-B360

Multi-Sensor No-Splicing Panoramic Dome Network Camera

- 4 × 5MP 1/2.7" CMOS image sensor, low illuminance, high image definition
- 4-channel stream output, and each channel can output max. 5MP
- ROI, SMART H.264+/H.265+, flexible coding, applicable to various
- Support 4-channel 120dB WDR
- The intelligent functions of 4 channels can be enabled at the same time
- Intelligent detection: Tripwire, intrusion, fast moving (the three
- FlexStream: The 4 channels of images can be viewed in a defined
- Web5.0 interface design, which is friendly to users, and easy for operation
- Built-in efficient IR LED illuminator, and the max. illumination distance is
- Alarm: 3 in, 2 out; audio: 1 in, 1 out; 485; supports max. 256 G Micro SD
- 12V DC/POE power supply; 12V power output, and max. current 165mA;
- IP67, IK10 protection



Our code:
11463

4x2MP: IPC-PDBW8840-A180

Multi-Sensor Panoramic Dome Network Camera

- Four 2MP 1/2.8" CMOS image sensor, low illuminance, high image definition
- Outputs max. 8MP (4096 × 1800) @30 fps
- Built-in IR LED, max. IR distance: 30 m
- ROI, SMART H.264+/H.265+, flexible coding, applicable to various bandwidth and storage environments
- Intelligent functions: Crowd distribution map, Vehicle Density
- Abnormality detection: Motion detection, video tampering, scene changing, audio detection, no SD card, SD card full, SD card error, network disconnection, IP conflict, illegal access, and voltage detection
- Alarm: 2 in, 2 out; audio: 1 in, 1 out; 485; BNC; supports max. 256 G SD card
- 12V DC/24V AC/PoE power supply; easy for installation
- Supports object tracking
- IP67,IK10 protection



Multi Sensor



4x8MP: IPC-PFW83242-A180

Multi-Sensor Panoramic Bullet Network Camera

- 4 × 8MP, 1/1.8" CMOS image sensor, low illuminance, high image definition
- Outputs max. 32MP (8192 × 3840) @25/30 fps; with intelligent functions enabled, it can output 32MP (8192 × 3840) @25 fps
- Built-in IR LED, max. IR distance: 30 m
- ROI, SMART H.264+/H.265+, flexible coding, applicable to various bandwidth and storage environments.
- Intelligent detection: Intrusion, tripwire
- Intelligent functions: Crowd distribution map, Vehicle situation
- Supports object tracking and image correction
- Support video clip, the image can be clipped as needed
- Supports max. 256 G Micro SD card
- 12V DC power supply
- IP67, IK10 protection



Our code:

11454



Fisheye



IPC-EBW81242

12MP Panoramic Network IR Fisheye Camera

- 12MP, 1/1.7" CMOS image sensor
- Max output 12MP (4000×3000)@30fps
- 3D DNR,AWB,HLC, BLC,ROI, SVC, SMART H.264/H.265
- People counting in multiple areas, queuing management in multiple areas, heat map (number of people /time), and track map
- Smart detection
- 2/2 Alarm in/out, 1/1 audio in/out
- 12V DC/POE power support
- IP67, IK10 protection



Our code:

11400



IPC-EW5541-AS

5MP WizMind IR Fisheye Network Camera

- 5MP, 1/2.7" CMOS image sensor, low illuminance, high image definition
- Outputs max. 5MP (2592 × 1944) @25/30 fps
- H.265 codec, high compression rate, ultra-low bit rate
- Built-in efficient IR illuminator, and the max. illumination distance: 10 m
- ROI, SMART H.264+/H.265+, flexible coding, applicable to various bandwidth and storage environments
- 120dB WDR, 3D DNR, HLC, BLC, digital watermarking, applicable to various monitoring scenes
- Intelligent detection: Intrusion, tripwire, people counting in area
- Abnormality detection: Motion detection, video tampering, scene changing, audio detection, no SD card, SD card full, SD card error, network disconnection, IP conflict, illegal access, and voltage detection
- Alarm: 1 in, 1 out; audio: 1 in, 1 out; supports max. 256 G Micro SD card, built-in Mic
- 12V DC/PoE power supply, easy for installation
- Heat map for people counting. You can adjust the number of people, time threshold to generate a heat map, which can be exported



Our code:

11450



Dual lens



IPC-HDW8341XP-3D 2.8mm 3MP Dual-Lens People Counting AI Network Camera

- Two 1/2.8" 3-megapixel progressive scan STARVIS™ CMOS
- H.265 & H.264 triple-stream encoding
- 25fps@3MP (2048×1536)
- WDR (120dB), Day/Night (ICR), 3DNR, AWB, AGC, BLC
- Multiple network monitoring: Web viewer, CMS (DSS/PSS) & DMSS
- 2.8mm fixed lens
- Max. IR LEDs length 10m
- Micro SD-card, IP67, PoE
- People Counting: Supports line crossing people counting, region people counting
- Mounting Accessories (Included): Quick mounting board



Our code:
10166

Corner Series



IPC-HCBW8442P 4MP WDR IR Corner Network Camera

- 1/1.8" 4Megapixel progressive scan CMOS
- H.265 & H.264 triple-stream encoding
- 25/30 fps@2688 × 1520
- WDR (140 dB), Day/Night (ICR), 3D DNR, AWB, AGC, BLC
- 2.5 mm fixed lens, distortion correction
- 1/1 Alarm in/out, 1/1 audio in/out
- Max. IR LEDs Length 10 m
- IP67 and IK10+50J protection



Our code:
11402



LDC OFF



LDC ON

LDC (Lens Distortion Correction) has better adaptability to the lens and can minimize the angle of view sacrifice.

Triple lens



IPC-HFW8841X-E3-LB 8MP WizMind Triple-Lens Network Camera

- 8MP 1/1.8" CMOS and 2MP 1/2.8" CMOS image sensors, low lumi-
- Outputs max. 8MP (3840 × 2160@30 fps) .
- H.265 codec, high compression ratio, and ultra-low bit rate.
- Built-in IR light, and the max. illumination distance is 35 m.
- ROI, SMART H.264 +/H.265+, flexible coding, applicable to various
- WDR, 3D NR, HLC, BLC, digital watermarking, applicable to various
- Three intelligent resources switchable: IVS, face recognition, and
- Tripwire, intrusion, abandoned object, missing object, loitering detec-
- Stereo analysis: People number exception detection, running detec
- Alarm: 3 in, 2 out; audio: 1 in, 1 out; RS-485; BNC; max. 256 G Micro
- Supports HDCVI output, and outputs detail and panoramic image, and
- 12V DC/PoE power supply, 12V power output and max. current of
- IP67 protection.



Our code:
11464

12MP



IPC-HDBW71242H-Z 12MP IR Dome WizMind Network Camera

- 12MP 1/1.7" CMOS image sensor, high image definition
- Outputs max. 12MP (4000 × 3000) @25/30 fps
- H.265 codec, high compression rate, ultra-low bit rate
- Built-in IR LED, max. IR distance: 40 m
- Rotation mode, DWDR, 3D NR, HLC, BLC, digital watermarking
- ROI, SVC, SMART H.264+/H.265+, flexible coding, applicable to various bandwidth and storage environments
- Perimeter Protection , Face Detection , Video Metadata , ANPR , People Counting, Queue Management
- Alarm: 3 in, 2 out; audio: 1 in, 1 out; RS-485; BNC; supports max. 256 G SD card
- 24V AC/12V DC/PoE power supply; 12V DC power output, max. current 165mA; easy for installation.
- IP67, IK10 protection
- Five streams for three-channel HD video



Our code:
11465



IPC-HFW71242H-Z 12MP IR Bullet WizMind Network Camera

- 12MP 1/1.7" CMOS image sensor, high image definition
- Outputs max. 12MP (4000 × 3000) @25/30 fps
- H.265 codec, high compression rate, ultra-low bit rate
- Built-in IR LED, max. IR distance: 60 m
- Rotation mode, DWDR; 3D NR, HLC, BLC, digital watermarking
- ROI, SVC, SMART H.264+/H.265+, flexible coding, applicable to various bandwidth and storage environments
- Perimeter Protection , Face Detection , Video Metadata , ANPR , People Counting , Queue Management
- Alarm: 3 in, 2 out; audio: 1 in, 1 out; RS-485; BNC; supports max. 256 G SD card
- 24V AC/12V DC/PoE power supply (the power ports are different depending on the power supply); 12V DC power output, max. current 165mA; easy for installation.
- IP67, IK10 protection
- Five streams for three-channel HD video



Our code:
11466



8MP



IPC-HDBW7842H-Z4 8MP IR Dome WizMind Network Camera

- 8MP, 1/1.8" CMOS image sensor, low illuminance, high image definition
- Outputs max. 8MP(3840 × 2160) @25/30 fps
- H.264&H.265 coding, high compression ration
- WDR, day/night, 3D NR, AWB, HLC, BLC
- ROI, SVC, SMART H.264+/H.265+, flexible coding, applicable to various bandwidth and storage environments
- With deep learning algorithm, it supports people counting, face detection, perimeter protection etc
- Alarm: 3 in, 2 out; audio: 1 in, 1 out; RS-485; BNC; supports max. 256 G SD card
- 24V AC/PoE/12V DC power support
- Five streams for three-channel HD video
- IP67, IK10 protection
- 12V DC power output, max. current 165mA , easy for installation



Our code:
11467



8MP



Our code:
11468

IPC-HFW7842H-Z4 8MP IR Bullet WizMind Network Camera

- 8MP, 1/1.8" CMOS image sensor, low illuminance, high image definition
- Outputs max. 8MP(3840 × 2160) @25/30 fps
- H.264&H.265 coding, high compression ration
- WDR, day/night, 3D NR, AWB, HLC, BLC
- ROI, SVC, SMART H.264+/H.265+, flexible coding, applicable to various bandwidth and storage environments
- With deep learning algorithm, it supports people counting, face detection, perimeter protection etc
- Alarm: 3 in, 2 out; audio: 1 in, 1 out; RS-485; BNC; supports max. 256 G SD card
- 24V AC/12V DC/PoE power supply (the power ports are different depending on the power supply)
- Five streams for three-channel HD video
- IP67, IK10 protection
- 12V DC power output, max. current 165mA , easy for installation



4MP



Our code:
11469

IPC-HDBW7442HP-Z 4MP IR Dome WizMind Network Camera

- 4MP, 1/1.8" CMOS image sensor, low illuminance, high image definition
- Max outputs 4MP (2688×1520) @50 fps/60 fps
- H.264&H.265 coding, high compression ration
- Wide dynamic, day/night, 3D NR, AWB, HLC, BLC
- ROI, SVC, SMART H.264+/H.265+, flexible coding, applicable to various bandwidth and storage environments
- With deep learning algorithm, it supports people counting, face detection, perimeter protection etc
- Alarm: 3 in, 2 out; audio: 1 in, 1 out; RS-485; BNC; supports max. 256 G SD card
- 24V AC/PoE/12V DC power support
- Five streams for three-channel HD video
- IP67, IK10 protection grade
- 12V DC power output, max. current 165mA , easy for installation



Our code:
11470

IPC-HFW7442HP-Z4 4MP IR Bullet WizMind Network Camera

- 4MP, 1/1.8" CMOS image sensor, low illuminance, high image definition
- Max outputs 4MP (2688×1520) @50 fps/60 fps
- H.264&H.265 coding, high compression ration
- Wide dynamic, day/night, 3D NR, AWB, HLC, BLC
- ROI, SVC, SMART H.264+/H.265+, flexible coding, applicable to various bandwidth and storage environments
- With deep learning algorithm, it supports people counting, face detection, perimeter protection etc
- Alarm: 3 in, 2 out; audio: 1 in, 1 out; RS-485; BNC; supports max. 256 G SD card
- 24V AC/12V DC/PoE power supply (the power ports are different depending on the power supply)
- Five streams for three-channel HD video
- IP67, IK10 protection grade
- 12V DC power output, max. current 165mA , easy for installation

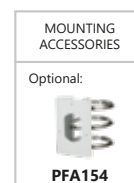

Full-Colour



Our code:
10352

IPC-HDW5442TM-AS-LED 2.8mm
4MP WDR Full-Colour Starlight AI Eyeball

- 1/1.8" 4-megapixel progressive scan CMOS
- H.265 & H.264 triple-stream encoding
- 25/30fps@2688×1520
- WDR (120dB), Day/Night (Electronic), 3D DNR, AWB, AGC, BLC
- Multiple network monitoring: Web viewer, CMS (DSS/PSS) & DMSS
- 2.8mm fixed lens
- Max. LEDs length 17m
- Micro SD-card, IP67



Our code:
10353

IPC-HFW5442T-AS-LED 3.6mm
4MP WDR Full-Colour Starlight AI Bullet

- 1/1.8" 4-megapixel progressive scan STARVIS™ CMOS
- H.265 & H.264 triple-stream encoding
- 25/30fps@4Mp (2688×1520)
- WDR (120dB), Day/Night (Electronic), 3DNR, AWB, AGC, BLC
- Multiple network monitoring: Web viewer, CMS (DSS/PSS) & DMSS
- 3.6mm fixed lens
- 1/1 Alarm in/out, 1/1 audio in/out
- Max. LEDs length 17m
- Micro SD-card, IP67



Active Deterrence



Our code:
11403

IPC-HDW5541H-AS-PV 2.8mm
5MP WDR IR Eyeball AI Network Camera

- 1/2.7" 5-megapixel progressive scan CMOS
- H.265 & H.264 triple-stream encoding
- 20fps@2592×1944
- WDR (120dB), Day/Night (ICR), 3D DNR, AWB, AGC, BLC
- Multiple network monitoring: Web viewer, CMS (DSS/PSS) & DMSS
- 2.8mm fixed lens (H: 102°, V: 71°)
- 1/1 Alarm in/out, 1/1 audio in/out (Built-in MIC, Built-in Speaker)
- Max. IR LEDs length 50m
- Micro SD-card, IP67



Integrated strobe light and built-in speaker

ACTIVE DETERRENCE



Our code:
11404

IPC-HFW5541T-AS-PV 3.6mm 5MP WDR IR Bullet AI Network Camera

- 1/2.7" 5-megapixel progressive scan STARVIS™ CMOS
- H.265 & H.264 triple-stream encoding
- 20fps@5Mp (2592×1944)
- WDR (120dB), Day/Night (ICR), 3DNR, AWB, AGC, BLC
- Multiple network monitoring: Web viewer, CMS (DSS/PSS) & DMSS
- 3.6mm fixed lens (H: 87°, V: 46°)
- 1/1 Alarm in/out, 1/1 audio in/out (Built-in Speaker)
- Max. IR LEDs length 60m
- Micro SD-card, IP67



MOUNTING ACCESSORIES

Options:



PFA130-E



PFA151



PFA152-E

Integrated strobe light and built-in speaker

5MP



Best Seller

Our code:
10348 (2.8mm)
10358 (3.6mm)

IPC-HDW5541TM-AS 2.8mm or 3.6mm 5MP WDR IR Eyeball AI Network Camera

- 1/2.7" 5Megapixel progressive scan CMOS
- H.265 & H.264 triple-stream encoding
- 20 fps@2592 × 1944, 50/60 fps@1080P (1920 × 1080)
- WDR (120 dB), Day/Night (ICR), 3D DNR, AWB, AGC, BLC
- Multiple network monitoring: Web viewer, CMS (DSS/PSS) & DMSS
- 2.8 mm or 3.6 mm fixed lens
- Built-in MIC · Max. IR LEDs Length 50 m
- Micro SD memory, IP67



MOUNTING ACCESSORIES

Options:



PFA151



PFA130-E



PFA106



PFB203W



PFB220C



PFA152-E



Our code:
10355

IPC-HDBW5541E-ZE 2.7-13.5mm 5MP Pro AI IR Vari-focal Dome Network Camera

- 1/2.7" 5Megapixel progressive scan CMOS
- H.265 & H.264 triple-stream encoding
- 20 fps@2592 × 1944, 50/60 fps@1080P (1920 × 1080)
- WDR (120 dB), Day/Night (ICR), 3D DNR, AWB, AGC, BLC
- Multiple network monitoring: Web viewer, CMS (DSS/PSS) & DMSS
- 2.7 mm–13.5 mm motorized lens
- 1/1 Alarm in/out, 1/1 audio in/out
- Max. IR LEDs Length 40 m
- Micro SD memory, IP67, IK10



MOUNTING ACCESSORIES

Options:



LR1002



PFA130-E



PFB210W



PFA138



PFB201C



PFA152-E



PFB300C

5MP



IPC-HDW5541TP-ZE 2.7-13.5mm

5MP IR Vari-focal Eyeball WizMind Network Camera

- 5MP, 1/2.7" CMOS image sensor, low illuminance, high image definition
- Outputs max. 5MP (2592 × 1944) @20 fps, 2MP(1920 × 1080) @60 fps
- Built-in IR LED, max. IR distance: 40 m
- ROI, SMART H.264+/H.265+, flexible coding, applicable to various bandwidth and storage environments
- Rotation mode, WDR, 3D DNR, HLC, BLC, digital watermarking, applicable to various monitoring scenes
- Intelligent detection: Tripwire, intrusion, fast moving (the three functions support the classification and accurate detection of vehicle and human), abandoned object, missing object, loitering detection, people gathering, parking detection, heat map, face detection, face attributes and people counting
- Supports max. 256 G Micro SD card, built-in Mic
- 12V DC/PoE power supply, ePoE network transmission over long distance, easy for installation
- IP67 protection



Our code:

11446

€165.00



IPC-HFW5541T-S 3.6mm or 2.8mm

5MP Pro AI IR Bullet Network Camera

- 1/2.7" 5Megapixel progressive scan CMOS
- H.265 & H.264 triple-stream encoding
- 20 fps@2592 × 1944, 50/60 fps@1080P (1920 × 1080)
- WDR (120 dB), Day/Night (ICR), 3D DNR, AWB, AGC, BLC
- Multiple network monitoring: Web viewer, CMS (DSS/PSS) & DMSS
- 3.6 mm or 2.8mm fixed lens
- Max. IR LEDs Length 80 m
- Micro SD memory, IP67,IK1



Our code:

10349 (3.6mm)

11426 (2.8mm)

BLACK

11439 (2.8mm)



IPC-HFW5541EP-Z5E

5MP Pro AI Vari-focal IR Bullet Network Camera

- 1/2.7" 5Megapixel progressive scan CMOS
- H.265 & H.264 triple-stream encoding
- 20 fps@2592 × 1944, 50/60 fps@1080P(1920 × 1080)
- WDR (120 dB), Day/Night (ICR), 3D DNR, AWB, AGC, BLC
- Multiple network monitoring: Web viewer, CMS (DSS/PSS) & DMSS
- 2/1 Alarm in/out, 1/1 audio in/out
- Max. IR LEDs Length 120m or 50m
- Micro SD memory, IP67, IK10

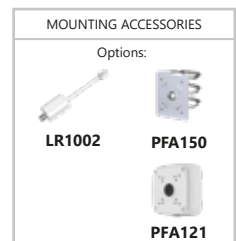

Our code:

10351 (7-35mm)

10350 (2.7-13.5mm)



TiOC 1.0

TiOC 1.0



Our code:

2MP (2.8mm)

11440

5MP (2.8mm)

11431

5MP (3.6mm)

11432

5MP BLACK (2.8mm)

11451

8MP (2.8mm)

11447

2MP: IPC-HDW3249H-AS-PV 2.8mm

5MP: IPC-HDW3549H-AS-PV 2.8mm or 3.6mm

8MP: IPC-HDW3849H-AS-PV 2.8mm

Full-color Active Deterrence Fixed-focal Eyeball

- 2MP 1/2.8" CMOS image sensor or 5MP 1/2.7" CMOS image sensor or 8MP 1/2.8" CMOS image sensor, low illuminance, high image definition
- H.265 codec, high compression rate, low bit rate
- Built-in warm illuminator, and the max. illumination distance: 30 m
- ROI, SMART H.264+/H.265+, flexible coding, applicable to various bandwidth and storage environments
- Rotation mode, WDR, 3D DNR, HLC, BLC, digital watermarking, applicable to various monitoring scenes
- Intelligent detection: Intrusion, tripwire (support the classification and accurate detection of vehicle and human)
- Abnormality detection
- Supports sound and light alarm linkage. When an alarm is triggered, the camera links sound alarm and light flashing.
- Supports one-tap disarming. You can disarm the events of alarm output, sending email, audio, and light in the configured period.
- Alarm: 1 in, 1 out; audio: 1 in, 1 out; supports max. 256 G Micro SD card, built-in Mic and speaker
- 12V DC/PoE power supply
- IP67 protection
- SMD Plus
- Red and blue flashlight alarm



TiOC 1.0



Our code:

5MP (2.8mm)

11433

5MP (3.6mm)

11434

8MP (3.6mm)

11448

5MP: IPC-HFW3549T1P-AS-PV 2.8mm or 3.6mm

8MP: IPC-HFW3849T1-AS-PV 3.6mm

Full-color Active Deterrence Fixed-focal Bullet

- 5MP, 1/2.7" CMOS image sensor or 8MP, 1/2.8" CMOS image sensor, low illuminance, high image definition
- H.265 codec, high compression rate, low bit rate
- Built-in warm illuminator, and the max. illumination distance: 40 m
- ROI, SMART H.264+/H.265+, flexible coding, applicable to various bandwidth and storage environments
- Rotation mode, WDR, 3D NR, HLC, BLC, digital watermarking, applicable to various monitoring scenes
- Intelligent detection: Intrusion, tripwire (support the classification and accurate detection of vehicle and human)
- Abnormality detection: Motion detection, video tampering, scene changing, audio detection, no SD card, SD card full, SD card error, network disconnection, IP conflict, illegal access, and voltage detection.
- Supports sound and light alarm linkage. When an alarm is triggered, the camera links sound alarm and light flashing.
- Supports one-tap disarming. You can disarm the events of alarm output, sending email, audio, and light in the configured period.
- Alarm: 1 in, 1 out; audio: 1 in, 1 out; supports max. 256 G Micro SD card, built-in Mic and speaker
- 12V DC/PoE power supply
- IP67 protection
- SMD Plus
- Red and blue flashlight alarm



Overview

New illumination, audio and image features and technologies have been introduced with the new TiOC 2.0, delivering superior images and a better user experience.



Smart Dual Illuminators
Seamlessly switches from IR to full colour mode



VoiceCatcher Technology
Longer pickup distance and less noise



Exceptional Image Quality
Large F1.0 aperture lens and high-performance sensor



One-touch Disarming
Convenient operation and easy integration



AI Features
Smart Motion Detection (SMD 3.0) and Perimeter Protection

Smart Dual Illumination: For Full Colour Performance

- 1 **Smart Illumination:** Has the ability to switch from IR Mode to white light when a target is detected. (Default)
- 2 **IR Mode:** Enables only the IR illuminator to turn on for scenes where white light is not required. It also has the benefit of no light pollution.
- 3 **White Light:** For events that require full colour images.

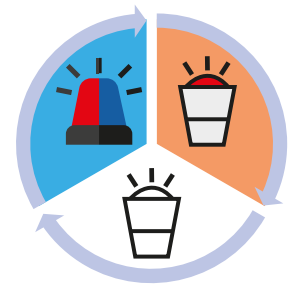

Smart Illumination mode adopts a deep learning algorithm to detect targets

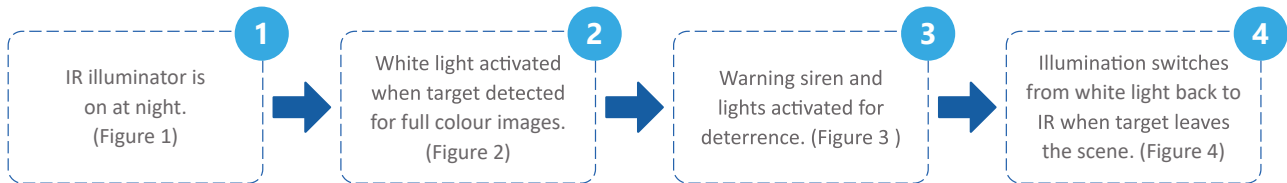

Figure 1



Figure 2

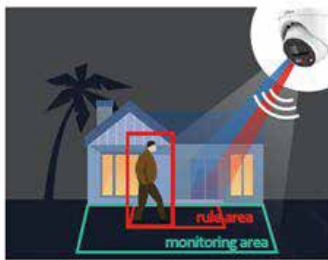

Figure 3



Figure 4

Products



TiOC 2.0

4MP: SD6C3425XB-HNR-A-PV1
25x Starlight IR WizSense Network PTZ TiOC 2.0

- 1/2.8" 4Megapixel STARVIS™ CMOS
- Powerful 25x optical zoom
- Starlight technology
- IR distance up to 150 m
- Perimeter protection · Face detection
- Metadata · Full-color illuminator; red and blue warning light
- IP66
- Smart dual illuminators (Recommended to use within 50 m)

| MOUNTING ACCESSORIES | |
|----------------------|-------------------|
| Included: | |
| | |
| PFA114 | AC24V/2.5A |
| Optional: | |
| | |
| PFB300C | PFB303W |
| | |
| PFB301C | PFA151 |
| | |
| PFB303S | PFA140 |



Our code:
10918

TiOC 2.0

Fixed-focal Eyeball WizSense Network Camera

- 8 MP 1/2.8" (or 5 MP 1/2.7") CMOS image sensor, low luminance, and high definition image.
- Outputs max. 8 MP (3840 × 2160)@25/30 fps (or Outputs max. 5 MP (2592 × 1944)@20 fps and supports 4 MP (2688 × 1520)@25/30 fps)
- H.265 codec, high compression rate, ultra-low bit rate.
- Built-in warm light and IR LED; the max. IR illumination distance is 30 m and warm light distance is 30 m.
- ROI, SMART H.264+/H.265+, AI H.264/H.265, flexible coding, applicable to various bandwidth and storage environments.
- Rotation mode, WDR, 3D NR, HLC, BLC, digital watermarking, applicable to various monitoring scenes.
- Intelligent monitoring: Intrusion, tripwire (the two function support the classification and accurate detection of vehicle and human).
- Abnormality detection: Motion detection, privacy masking, scene network disconnection, IP conflict, illegal access, and voltage detection.
- Alarm: 1 in, 1 out; audio: 1 in, 1 out; supports max. 256 G Micro SD card; built-in dual MICs; 1-ch speaker.
- 12 VDC/PoE power supply.
- IP67 protection.
- Sound and light alarm (red and blue lights).
- SMD 3.0.
- One press arming/disarming through alarm input.
- 2.8mm fixed lens.



Our code

| | | | |
|--------------|---------------------------------|--|--|
| 11473 | DH-IPC-HDW3549HP-AS-PV-S3 | Dahua IP 5MP TiOC 2.0 IR & LED Dome 2.8mm | |
| 11474 | DH-IPC-HDW3849HP-AS-PV-S3 | Dahua IP 8MP TiOC 2.0 IR & LED Dome 2.8mm | |
| 11477 | DH-IPC-HDW3549HP-AS-PV-S3 BLACK | Dahua IP 5MP TiOC 2.0 Dome 2.8mm Black | |
| 11478 | DH-IPC-HDW3849HP-AS-PV-S3 BLACK | Dahua IP 8MP TiOC 2.0 Dome 2.8mm Black | |

Fixed-focal Bullet WizSense Network Camera

- 8MP 1/2.8" (or 5MP, 1/2.7) CMOS image sensor, low luminance, and high definition
- Outputs max. 8 MP (3840 × 2160)@25/30 fps (or Outputs max. 5MP (2592 × 1944) @20 fps, and supports 4MP (2688 × 1520) @25/30 fps)
- H.265 codec, high compression rate, ultra-low bit rate.
- Built-in warm light and IR LED; the max. IR illumination distance is 30 m and warm light distance is 30 m.
- ROI, SMART H.264+/H.265+, AI H.264/H.265, flexible coding, applicable to various bandwidth and storage environments.
- Rotation mode, WDR, 3D NR, HLC, BLC, digital watermarking, applicable to various monitoring scenes.
- Intelligent monitoring: Intrusion, tripwire (the two function support the classification and accurate detection of vehicle and human).
- Abnormality detection: Motion detection, privacy masking, scene changing, audio detection, no SD card, SD card full, SD card error, network disconnection, IP conflict, illegal access, and voltage detection.
- Alarm: 1 in, 1 out; audio: 1 in, 1 out; supports max. 256 G Micro SD card; built-in dual MICs; 1-ch speaker.
- 12 VDC/PoE power supply.
- IP67 protection.
- Sound and light alarm (red and blue lights).
- SMD 3.0.
- One-click arming/disarming through alarm input.
- 3.6mm fixed lens.



Our code

| | | | |
|--------------|----------------------------|--|--|
| 11475 | DH-IPC-HFW3549T1P-AS-PV-S3 | Dahua IP 5MP TiOC 2.0 IR & LED Bullet 3.6mm | |
| 11476 | DH-IPC-HFW3849T1P-AS-PV-S3 | Dahua IP 8MP TiOC 2.0 IR & LED Bullet 3.6mm | |

8MP/5MP/4MP/2MP



Our code:

5MP

11456

4MP

11409

5MP: IPC-HDBW3541F-AS-M 2.8mm

4MP: IPC-HDBW3441F-AS-M 2.8mm

IR Fixed focal Dome WizSense

- 5MP, 1/2.7" CMOS image sensor, low illuminance, high image definition or 4MP, 1/3" CMOS image sensor
- AI coding, high compression rate, low bit rate
- Built-in IR LED, max. IR distance: 30 m
- Rotation mode, WDR
- Intelligent detection: Intrusion, tripwire
- Supports max. 256 G Micro SD card, built-in Mic
- IK10 protection
- 2.8mm fixed lens



Our code:

8MP

11444

5MP

11396

5MP BLACK

11429

8MP: IPC-HDW3841EMP-AS 2.8mm

5MP: IPC-HDW3541EMP-AS 2.8mm

IR Fixed focal Eyeball WizSense

- 8MP, 1/2.8" CMOS image sensor, low illuminance, high image definition or 5MP; 1/2.7" CMOS image sensor
- H.265 codec, high compression rate, low bit rate
- Built-in IR LED, max. IR distance: 30 m
- ROI, SMART H.264+/H.265+, flexible coding, applicable to various bandwidth and storage environments.
- Rotation mode, WDR, 3D DNR, HLC, BLC
- Intelligent detection: Intrusion, tripwire (support the classification and accurate detection of vehicle and human)
- Abnormality detection
- Supports max. 256 G Micro SD card, built-in Mic
- 12V DC/PoE power supply
- IP67 protection
- SMD Plus



Our code:

11449

IPC-HDBW3541EP-AS 2.8mm

5MP IR Fixed focal Dome WizSense

- 5MP, 1/2.7" CMOS image sensor, low illuminance, high image definition
- H.265 codec, high compression rate, low bit rate
- Built-in IR LED, max. IR distance: 50 m
- ROI, SMART H.264+/H.265+, flexible coding, applicable to various bandwidth and storage environments
- Rotation mode, WDR, 3D DNR, HLC, BLC, digital watermarking, applicable to various monitoring scenes
- Intelligent detection: Intrusion, tripwire (support the classification and accurate detection of vehicle and human)
- Abnormality detection
- Alarm: In, out; Audio: In, out; Supports max. 256 G Micro SD card
- 12V DC/POE power supply
- IP67, IK10 protection
- SMD Plus



8MP/5MP/4MP/2MP



Our code:
11455

IPC-HDW3241TM-AS 2.8mm 2MP IR Fixed focal Eyeball WizSense

- 2MP, 1/2.8" CMOS image sensor, low illuminance, high image definition
- Outputs max. 2MP (1920 × 1080)@30 fps
- H.265 codec, high compression rate, low bit rate
- Built-in IR LED, max. IR distance: 50 m
- ROI, SMART H.264+/H.265+, flexible coding, applicable to various bandwidth and storage environments
- Rotation mode, WDR, 3D DNR, HLC, BLC, digital watermarking, applicable to various monitoring scenes
- Intelligent detection: Intrusion, tripwire (support the classification and accurate detection of vehicle and human)
- Abnormality detection
- Supports max. 256 G Micro SD card, built-in Mic
- 12V DC/POE power supply
- IP67 protection
- SMD Plus



Our code:
8MP
11445
5MP
11397
2MP
11459

8MP: IPC-HDW3841TP-ZAS 2.7-13.5mm 5MP: IPC-HDW3541T-ZAS 2.7-13mm 2MP: IPC-HDW3241T-ZAS 2.7-13mm IR Vari-focal Eyeball WizSense

- 8MP 1/2.8" CMOS image sensor or 5MP 1/2.7" CMOS image sensor or 2MP, 1/2.8" CMOS image sensor, low illuminance, high image definition
- H.265 codec, high compression rate, low bit rate
- Built-in IR LED, max. IR distance: 40 m
- Rotation mode, WDR
- Intelligent detection: Intrusion, tripwire
- Supports max. 256 G Micro SD card, built-in Mic
- 2.7mm - 13mm vari-focal lens



Our code:
8MP (3.6mm)
11442
5MP (3.6mm)
11398
5MP (2.8mm)
11436

8MP: IPC-HFW3841EP-AS 3.6mm 5MP: IPC-HFW3541EP-AS 3.6mm or 2.8mm IR Fixed focal Bullet WizSense

- 5MP 1/2.7" CMOS image sensor or 8MP 1/2.8" CMOS image sensor, low illuminance, high image definition
- Outputs max. 5MP (2592 × 1944)@20 fps
- H.265 codec, high compression rate, low bit rate
- Built-in IR LED, max. IR distance: 50 m
- ROI, SMART H.264+/H.265+, flexible coding, applicable to various bandwidth and storage environments
- Rotation mode, WDR, 3D DNR, HLC, BLC, digital watermarking, applicable to various monitoring scenes
- Intelligent detection: Intrusion, tripwire
- Abnormality detection: Motion detection, video tampering, scene changing, audio detection, no SD card, SD card full, SD card error, network disconnection, IP conflict, illegal access, voltage detection
- Supports max. 256 G Micro SD card, built-in Mic
- 12V DC/POE power support
- IP67 protection
- SMD
- 3.6mm or 2.8mm fixed lens



8MP/5MP/4MP/2MP



2MP: IPC-HFW3241E-SA 3.6mm IR Fixed focal Bullet WizSense

- 2MP, 1/2.8" CMOS image sensor, low illuminance, high image definition
- Outputs max. 2MP (1920 × 1080)@30 fps
- H.265 codec, high compression rate, low bit rate
- Built-in IR LED, max. IR distance: 50 m
- ROI, SMART H.264+/H.265+, flexible coding, applicable to various bandwidth and storage environments
- Rotation mode, WDR, 3D DNR, HLC, BLC, digital watermarking, applicable to various monitoring scenes
- Intelligent detection: Intrusion, tripwire (support the classification and accurate detection of vehicle and human)
- Abnormality detection: Motion detection, video tampering, scene changing, audio detection, no SD card, SD card full, SD card error, network disconnection, IP conflict, illegal access, voltage detection
- Supports max. 256 G Micro SD card, built-in Mic
- 12V DC/POE power supply
- IP67 protection
- SMD Plus



Our code:
11457



8MP: IPC-HFW3841TP-ZAS 2.7-13.5mm 5MP: IPC-HFW3541T-ZS 2.7-13.5mm 2MP: IPC-HFW3241TP-ZAS 2.7-13.5mm IR Vari-focal Bullet WizSense Network Camera

- 8MP or 5MP or 2MP, 1/2.7" CMOS image sensor, low illuminance, high image definition
- Outputs max. 5MP (2592 × 1944)@20 fps
- H.265 codec, high compression rate, low bit rate
- Built-in IR LED, max. IR distance: 60 m
- ROI, SMART H.264+/H.265+, flexible coding, applicable to various bandwidth and storage environments
- Rotation mode, WDR, 3D DNR, HLC, BLC, digital watermarking, applicable to various monitoring scenes
- Intelligent detection: Intrusion, tripwire
- Abnormality detection: Motion detection, video tempering, scene changing, no SD card, SD card full, SD card error, network disconnection, IP conflict, illegal access, voltage detection
- Supports max. 256 G Micro SD card
- 12V DC/POE power support
- IP67 protection
- SMD Plus



8MP
11443

5MP
11399

2MP
11458



FULL COLOUR



5MP (2.8mm)

11452

5MP (3.6mm)

11438

5MP BLACK (2.8mm)

11453

5MP: IPC-HDW3549TM-AS-LED 2.8mm

5MP: IPC-HDW3549TM-AS-LED 3.6mm

Full-color Fixed-focal Warm LED Eyeball

- 5MP, 1/2.7" CMOS image sensor, low illuminance, high image definition
- Outputs max. 5MP (2592 × 1944) @20 fps, and supports 4MP (2688 × 1520) @25/30 fps
- H.265 codec, high compression rate, ultra-low bit rate
- Built-in warm light, max. illumination distance: 30 m
- ROI, SMART H.264+/H.265+, flexible coding, applicable to various bandwidth and storage environments
- Rotation mode, WDR, 3D DNR, HLC, BLC, digital watermarking, applicable to various monitoring scenes
- Intelligent detection: Intrusion, tripwire (support the classification and accurate detection of vehicle and human)
- Abnormality detection: Motion detection, video tampering, scene changing, audio detection, no SD card, SD card full, SD card error, network disconnection, IP conflict, illegal access, voltage detection
- Supports max. 256 G Micro SD card, built-in Mic
- 12V DC/PoE power supply, easy for installation
- IP67 protection
- SMD Plus



5MP (3.6mm)

11437

5MP: IPC-HFW3549E-AS-LED 3.6mm

Full-color Fixed-focal Warm LED Bullet

- 5MP, 1/2.7" CMOS image sensor, low illuminance, high image definition
- Outputs max. 5MP (2592 × 1944) @20 fps, and supports 4MP (2688 × 1520) @25/30 fps
- H.265 codec, high compression rate, low bit rate
- Built-in warm light, max. illumination distance: 30 m
- ROI, SMART H.264+/H.265+, flexible coding, applicable to various bandwidth and storage environments
- Rotation mode, WDR, 3D DNR, HLC, BLC, digital watermarking, applicable to various monitoring scenes
- Intelligent detection: Intrusion, tripwire (support the classification and accurate detection of vehicle and human)
- Abnormality detection: Motion detection, video tampering, scene changing, audio detection, no SD card, SD card full, SD card error, network disconnection, IP conflict, illegal access, voltage detection
- Alarm: 1 in, 1 out; Audio: 1 in, 1 out; supports max. 256 G Micro SD card, built-in Mic
- 12V DC/PoE power supply, easy for installation
- IP67 protection
- SMD Plus





Best Seller

Our code:
11392

8MP: IPC-HDW2831T-AS-S2 2.8mm
Lite IR Fixed-focal Eyeball Network Camera

- 8MP, 1/2.7" CMOS image sensor, low illuminance, high image definition
- Outputs max. 8MP (3840 × 2160)@15fps, and supports 2688×1520 @25/30 fps
- H.265 codec, high compression rate, ultra-low bit rate
- Built-in IR LED, max IR distance: 30 m
- ROI, SMART H.264/H.265, flexible coding, applicable to various bandwidth and storage environments
- Rotation mode, WDR, 3D DNR, HLC, BLC, digital watermarking, applicable to various monitoring scenes
- Intelligent detection: Intrusion, tripwire
- Supports max. 256 GB Micro SD card, built-in MIC
- 12V DC/PoE power support
- 2.8mm fixed lens



Our code:
11395

8MP: IPC-HDBW2831E-S-S2 2.8mm
Lite IR Fixed-focal Dome Network Camera

- 8MP, 1/2.7" CMOS image sensor, low illuminance, high image definition
- Outputs max. 8MP (3840 × 2160) @15 fps, and supports 2688×1520 @25/30 fps
- H.265 codec, high compression rate, ultra-low bit rate
- Built-in IR LED, max IR distance: 30 m
- ROI, SMART H.264/H.265, flexible coding, applicable to various bandwidth and storage environments
- Rotation mode, WDR, 3D DNR, HLC, BLC, digital watermarking, applicable to various monitoring scenes
- Intelligent detection: Intrusion, tripwire
- Supports max. 256 GB Micro SD card
- 12V DC/PoE power support
- IP67, IK10 protection
- 2.8mm fixed lens

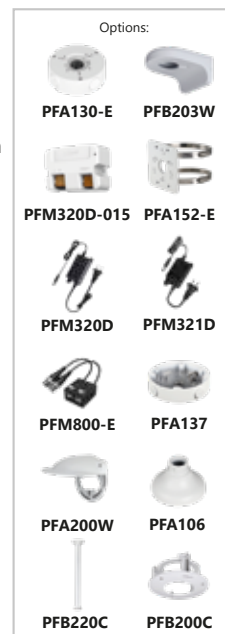

Our code:
8MP

11393

5MP

11486

5MP BLACK

11489

4MP

11410

8MP: IPC-HDW2831T-ZS-S2 2.7-13.5mm
5MP: IPC-HDW2531T-ZS-S2 2.7-13.5mm
4MP: IPC-HDW2431T-ZS-S2 2.7-13.5mm
WDR IR Eyeball Network Camera

- CMOS image sensor, low illuminance, high image definition
- Outputs max. 8MP (3840 × 2160) @15 fps and supports 8MP (2688×1520) @25/30 fps, Outputs 4MP (2560 × 1440)@25/30 fps and max. supports 4MP (2688 × 1520)@20 fps, Outputs max. 5MP (2592 × 1944) @20 fps and supports 2688 × 1520 (2688 × 1520) @25/30 fps
- H.265 codec, high compression rate, ultra-low bit rate
- Built-in IR LED, max IR distance: 40 m
- ROI, SMART H.264/H.265, flexible coding, applicable to various bandwidth and storage environments
- Rotation mode, WDR, 3D DNR, HLC, BLC, digital watermarking, applicable to various monitoring scenes
- Intelligent detection: Intrusion, tripwire
- Supports max. 256 GB Micro SD card
- 12V DC/POE power support
- IP67 protection



2 series



5MP
11483
5MP BLACK
11482

5MP: IPC-HDW2531TM-AS-S2 2.8mm
Lite IR Fixed-focal Eyeball Network Camera

- 5MP, 1/2.7" CMOS image sensor, low illuminance, high image definition
- Outputs max. 5MP (2592 × 1944) @20 fps, and supports 2688 × 1520 (2688 × 1520) @25/30 fps
- H.265 codec, high compression rate, ultra-low bit rate
- Built-in IR LED, max IR distance: 30 m
- ROI, SMART H.264+/H.265+, flexible coding, applicable to various bandwidth and storage environments
- Rotation mode, WDR, 3D NR, HLC, BLC, digital watermarking, applicable to various monitoring scenes
- Intelligent detection: Intrusion, tripwire
- Abnormality detection
- Supports max. 256 GB Micro SD card, built-in Mic
- 12V DC/PoE power supply
- IP67 protection



Our code:
11390

4MP: IPC-HDW2431TM-AS-S2 2.8mm
WDR IR Eyeball Network Camera

- CMOS image sensor, low illuminance, high image definition
- Outputs 4MP (2560 × 1440)@25/30 fps, Max. supports 4MP (2688 × 1520)@20 fps, Outputs max. 2MP (1920 × 1080) @25/30 fps
- H.265 codec, high compression rate, ultra-low bit rate
- Built-in IR LED, max IR distance: 30 m
- ROI, SMART H.264/H.265, flexible coding, applicable to various bandwidth and storage environments
- Rotation mode, WDR, 3D DNR, HLC, BLC, digital watermarking, applicable to various monitoring scenes
- Intelligent detection: Intrusion, tripwire
- Supports max. 256 GB Micro SD card, built-in Mic
- 12V DC/POE power support
- IP67 protection
- 2.8mm fixed lens



1 series



Our code:
11485

5MP: IPC-HDW1530T-S6 2.8mm
Lite IR Fixed-focal Eyeball Network Camera

- 5MP 1/2.7" CMOS image sensor, low luminance, and high definition image.
- Outputs max. 5MP (2880 × 1620) @20 fps and supports 2688 × 1520 (2688 × 1520) @25/30 fps.
- H.265 codec, high compression rate, and ultra-low bit rate.
- Built-in IR LED, and the max. illumination distance is 30 m.
- ROI, SMART H.264 +/H.265+, flexible coding, applicable to various bandwidth and storage environments.
- Rotation mode, DWDR, 3D NR, HLC, BLC, digital watermarking, applicable to various monitoring scenes.
- Abnormality detection: Motion detection, video tampering, audio detection, network disconnection, IP conflict, and illegal access.
- Built-in MIC.
- 12 V DC/PoE power supply.
- IP67 protection.





Our code:
8MP

11414

4MP

11413

8MP: IPC-HFW2831S-S-S2 3.6mm
4MP: IPC-HFW2431S-S-S2 3.6mm
WDR IR Bullet Network Camera

- CMOS image sensor, low illuminance, high image definition
- Outputs max. 8MP (3840 × 2160) @15 fps, and supports 2688×1520 @25/30 fps, Outputs 4MP (2560 × 1440)@25/30fps and Max. supports 4MP (2688 × 1520)@20 fps, Outputs max. 2MP (1920 × 1080) @25/30 fps
- H.265 codec, high compression rate, ultra-low bit rate
- Built-in IR LED, max IR distance: 30 m
- ROI, SMART H.264/H.265, flexible coding, applicable to various bandwidth and storage environments
- Rotation mode, WDR, 3D DNR, HLC, BLC, digital watermarking, applicable to various monitoring scenes
- Intelligent detection: Intrusion, tripwire
- Abnormality detection: Motion detection, video tampering, no SD card, SD card full, SD card error, network disconnection, IP conflict, illegal access, voltage detection
- Supports max. 256 GB Micro SD card
- 12V DC/PoE power support
- IP67 protection



Our code:
8MP

11394

4MP

11415

8MP: IPC-HFW2831T-ZS 3.7-11mm
4MP: IPC-HFW2431T-ZS-S2 2.7-13.5mm
WDR IR Bullet Network Camera

- 8, 4, 2 Megapixel progressive CMOS
- H.265 & H.264 dual-stream encoding
- 25/30fps@8MP (3840×2160), @4MP (2560×1440), @2MP (1920×1080)
- WDR(120dB), Day/Night(ICR), 3DNR, AWB, AGC, BLC
- Multiple network monitoring: Web viewer, CMS(DSS/PSS) & DMSS
- Micro SD card slot, up to 128GB (8MP)
- Supports max. 256 GB Micro SD card (4MP, 2MP)
- Max IR LEDs Length 60m
- IP67, IK10 (optional)



Our code:
5MP

11487

5MP: IPC-HFW2531TP-AS-S2 3.6mm
IR Fixed-focal Bullet Network Camera

- 5MP, 1/2.7" CMOS image sensor, low illuminance, high image definition
- Outputs max. 5MP (2592 × 1944) @20 fps, and supports 2688 × 1520 (2688 × 1520) @25/30 fps
- H.265 codec, high compression rate, ultra-low bit rate
- Built-in IR LED, max IR distance: 80 m
- ROI, SMART H.264+/H.265+, flexible coding, applicable to various bandwidth and storage environments
- Rotation mode, WDR, 3D NR, HLC, BLC, digital watermarking, applicable to various monitoring scenes
- Intelligent detection: Intrusion, tripwire
- Abnormality detection: Motion detection, video tampering, no SD card, SD card full, SD card error, network disconnection, IP conflict, illegal access, local alarm, voltage detection, audio detection
- Alarm: 1 in, 1 out; audio: 1 in, 1 out; supports max. 256 GB Micro SD card
- 12V DC/POE power support supply
- IP67 protection, IK10 protection (optional)



Lite series



Our code:
5MP
11488

5MP: IPC-HFW2531T-ZS-S2 2.7 mm–13.5 mm IR Vari-focal Bullet Network Camera

- 5MP, 1/2.7" CMOS image sensor, low illuminance, high image definition
- Outputs max. 5MP (2592 × 1944) @20 fps, and supports 2688 × 1520 (2688 × 1520) @25/30 fps
- H.265 codec, high compression rate, ultra-low bit rate
- Built-in IR LED, max IR distance: 60 m
- ROI, SMART H.264+/H.265+, flexible coding, applicable to various bandwidth and storage environments
- Rotation mode, WDR, 3D NR, HLC, BLC, digital watermarking, applicable to various monitoring scenes
- Intelligent detection: Intrusion, tripwire
- Abnormality detection: Motion detection, video tampering, no SD card, SD card full, SD card error, network disconnected, IP conflict, illegal access, voltage detection
- Supports max. 256 GB Micro SD card
- 12V DC/PoE power supply
- IP67 protection



Special series



Our code:
10332

IPC-HUM8431-E1

4MP Covert Pinhole Network Camera-Main Box

- H.265&H.264 triple-stream encoding
- Support Smart H.265+/H.264+
- 25/30fps@4M(2688×1520)
- Day/Night(Electronic), WDR, 3DNR, AWB, AGC, BLC
- Smart detection
- Micro SD memory, PoE
- Multiple Lens Unit optional
- Require a Lens Unit to work together



Our code:
10333

IPC-HUM8431-L1

4MP Covert Pinhole Network Camera-Lens Unit

- 1/2.7" 4Megapixel progressive scan CMOS
- Day/Night(Electronic), WDR
- 2.8mm Fixed Pinhole Lens
- 8-meters cable
- Require a Main Box to work together



Our code:
10335

IPC-HUM8431-L4

4MP Covert Pinhole Network Camera-Lens Unit

- 1/2.7" 4Megapixel progressive scan CMOS
- Day/Night(Electronic), WDR
- 2.8mm Fixed Pinhole Lens
- 8-meters cable
- Require a Main Box to work together





Our code:
10338

ITC952-AU3F-LZF1640
9MP All-in-one AI Enforcement Camera

- GS-CMOS image sensor
- 4096×2820@50fps
- Video compression standards: H.265/H.264M/H.264H/H.264B/MJPEG
- Integrated design, IP66

MOUNTING ACCESSORIES

Needed:

PFA162



Our code:
10336

ITC352-AU3F-IRL8ZF1640
3MP All-in-one IR AI Enforcement Camera

- GS-CMOS image sensor.
- 2048 × 1536@50fps.
- Video compression standards: H.265/H.264M/H.264H/H.264B/MJPEG.
- Integrated design, IP66.
- 850 nm IR illumination.

MOUNTING ACCESSORIES

Needed:

PFA162



Our code:
10347

ITC215-PW4I-IRL
2MP Full HD AI Access ANPR Camera

- 1/2.8 inch 2Megapixel Progressive scan CMOS
- WDR, Day/Night(ICR), 3DNR,BLC, HLC
- H.265& H.264 dual-stream encoding
- Powerful 2.7-13.5mm motorised lens and IR light, ideal for monitor ANPR distance 3-8m
- Micro SD memory
- IP67, and superior performance for outdoor applications
- Embedded with LPR algorithm inside the camera
- Vehicle data structuring: license plate recognition, vehicle size, vehicle color detection and etc.



Our code:
10359

ITC237-PW6M-IRLZF1050-B 10-50mm
2MP IR License Plate Recognition Varifocal Camera

- 1/1.8-in. 2 MP GS CMOS Sensor
- License Plate Recognition Distance up to 30 m (98.43 ft)
- Capture and Recognize License Plates from Vehicles Traveling up to 80km/h
- Dual-stream Encoding
- H.265 and H.264 Dual Codec
- 1080p at 30 fps Maximum Resolution
- 10 mm to 50 mm Motorized Vari-focal Lens
- Maximum IR LED Distance 25 m (82 ft)
- 12 VDC, 1 A Power Output
- IP67 Ingress Protection

MOUNTING ACCESSORIES

Options:

PFA162

1.2M POLE



Our code:
10903

4MP: SDT5X425-4Z4-WA-2812

Starlight IR WizMind Network Dual-PTZ Camera

- Dual PTZ system, dual vari-focal lens
- 1/1.8" 4Megapixel CMOS
- Powerful 25x optical zoom
- Starlight technology
- Max. 50/60 fps@4M
- Deep-learning-based auto tracking and perimeter protection
- Support Hi-PoE
- H.265 Encoding
- IP67



| MOUNTING ACCESSORIES | |
|----------------------|------------------|
| Included: | |
| | PFB306W-S |
| Optional: | |
| | PFB300C-S |
| | PFA150 |



Our code:
4K
10906
4MP
10907

4K: SD10A848WA-HNF 4MP: SD10A448WA-HNF

48x Starlight + IR WizMind Network PTZ Camera

- 1/1.8" 8Megapixel STARVIS™ CMOS or 1/1.8" 4Megapixel CMOS
- Powerful 48x optical zoom
- Starlight+ technology
- IR distance up to 450m
- Deep-learning-based auto tracking and perimeter protection
- Support metadata
- Support Hi-PoE
- Smart wiper
- IP67



| MOUNTING ACCESSORIES | |
|----------------------|-----------------|
| Included: | |
| | |
| PFB710W | AC24V/3A |
| | |
| PFA111 | |
| Optional: | |
| | |
| PFB300C | PFA140 |
| | |
| PFA150 | PFA120 |
| | |
| PFB303S | PFA151 |



Best Seller

Our code:
10890

4MP: SD6AL445XA-HNR-IR

45x Starlight IR PTZ AI

- 1/2.8" 4Megapixel CMOS
- Powerful 45x optical zoom
- Starlight technology
- Max. 50/60 fps@1080P
- Deep-learning-based auto tracking and perimeter protection
- Support face detection
- Support Hi-PoE
- SMD
- IP67



| MOUNTING ACCESSORIES | |
|----------------------|-----------------|
| Included: | |
| | |
| PFB303W | AC24V/3A |
| | |
| PFA111 | |
| Optional: | |
| | |
| PFB300C | PFA120 |
| | |
| PFA150 | PFA151 |
| | |
| PFB303S | PFA140 |



TiOC 2.0

Our code:
10918

**4MP: SD6C3425XB-HNR-A-PV1
25x Starlight IR WizSense Network PTZ TiOC 2.0**

- 1/2.8" 4Megapixel STARVIS™ CMOS
- Powerful 25x optical zoom
- Starlight technology
- IR distance up to 150 m
- Perimeter protection · Face detection
- Metadata · Full-color illuminator; red and blue warning light
- IP66
- Smart dual illuminators (Recommended to use within 50 m)



| MOUNTING ACCESSORIES | |
|----------------------|------------|
| Included: | |
| PFA114 | AC24V/2.5A |
| Optional: | |
| PFB300C | PFB303W |
| PFB301C | PFA151 |
| PFB303S | PFA140 |



Invisible
Lens

Our code:
10908

**8MP: SD5A825-HNR-YA
25x Starlight IR WizSense Network PTZ Camera**

- 1/1.8" 8Megapixel CMOS
- Powerful 25x optical zoom
- Starlight Technology
- Max. 25/30fps@8MP
- IR distance up to 150m
- Deep-learning-based auto tracking and perimeter protection
- Auto-tracking and IVS
- PoE+
- IP67 , IK10



| MOUNTING ACCESSORIES | |
|----------------------|---------|
| Included: | |
| AC24V/3A | PFB305W |
| Optional: | |
| PFA140 | PFA120 |
| PFB300C | PFB303S |
| PFA151 | PFA150 |
| | PFA111 |



Invisible
Lens

Our code:
10899

**4MP: SD5A445XA-HNR
45x Starlight IR WizSense Network PTZ Camera**

- 1/2.8" 4Megapixel STARVIS™ CMOS
- Powerful 45x optical zoom
- Starlight technology
- Max. 25/30fps@4MP
- IR distance up to 150m
- SMD Plus
- Deep-learning-based auto tracking and perimeter protection
- Auto-tracking and IVS
- PoE+
- IP67 , IK10



| MOUNTING ACCESSORIES | |
|----------------------|---------|
| Included: | |
| AC24V/3A | PFB305W |
| Optional: | |
| PFA140 | PFA120 |
| PFB300C | PFB303S |
| PFA151 | PFA150 |
| | PFA111 |



Our code:
10909

4MP: SD5A432XA-HNR 32x Starlight IR WizSense Network PTZ Camera

- 1/2.8" 4Megapixel STARVIS™ CMOS
- Powerful 32x optical zoom
- Max. 25/30fps@4M
- IR distance up to 150 m
- Deep-learning-based auto tracking and perimeter protection
- SMD PLUS
- PoE+
- IP67, IK10
- Face Detection



| MOUNTING ACCESSORIES | |
|----------------------|---------|
| Included: | |
| AC24V/3A | PFB305W |
| Optional: | |
| PFA140 | PFA120 |
| PFB300C | PFB303S |
| PFA151 | PFA150 |
| | PFA111 |



Our code:
4MP
10894
2MP
10902

4MP: SD5A425XA-HNR 2MP: SD5A225XA-HNR 25x Starlight IR PTZ AI Network Camera

- 1/1.8" 4Megapixel CMOS or 1/2.8" 2Megapixel STARVIS™ CMOS
- Powerful 25x optical zoom
- Starlight+ Technology
- Max. 25/30fps@4MP
- IR distance up to 150m
- Deep-learning-based auto tracking and perimeter protection
- Auto-tracking and IVS
- PoE+
- IP67, IK10
- Anti corrosion coating



| MOUNTING ACCESSORIES | |
|----------------------|---------|
| Included: | |
| | PFB305W |
| Optional: | |
| PFB300C | PFA111 |
| | PFA150 |



Our code:
10910

4MP: SD49425XB-HNR-G 25x Starlight IR 4G WizSense Network PTZ Camera

- 1/2.8" 4Megapixel CMOS
- Support 4G
- Powerful 25x optical zoom
- Starlight technology
- Max.25/30fps@4M
- Perimeter Protection
- Support PoE+
- IR distance up to 100m
- SMD PLUS
- IP66



| MOUNTING ACCESSORIES | |
|----------------------|---------|
| Included: | |
| | PFB305W |
| Optional: | |
| PFA140 | PFA120 |
| PFB300C | PFB303S |
| PFA151 | PFA150 |
| DC12V/3A | PFA111 |



Best Seller

Our code:
10892

2MP: SD49225XA-HNR 25x Starlight IR WizSense Network PTZ Camera

- 1/2.8" 2Megapixel CMOS
- Powerful 25x optical zoom
- Starlight technology
- Max. 50/60fps@1080P
- Perimeter protection
- Support PoE+
- IR distance up to 100m
- SMD PLUS
- IP66



| MOUNTING ACCESSORIES | |
|----------------------|----------------|
| Included: | |
| | |
| PFB305W | |
| Optional: | |
| | |
| PFA140 | PFA120 |
| | |
| PFB300C | PFB303S |
| | |
| PFA151 | PFA150 |
| | |
| DC12V/3A | PFA111 |



Our code:
10917

2MP: SD52C232XA-HNR 32x In-Ceiling WizSense PTZ

- 1/2.8" 2Megapixel STARVIS™ CMOS
- Powerful 32x optical zoom
- Max. 50/60 fps@1080P
- Starlight technology
- Deep-learning-based auto tracking and perimeter protection
- SMD PLUS
- PoE+
- Face Detection
- IK10



| MOUNTING ACCESSORIES | |
|----------------------|---------------|
| Optional: | |
| | |
| PFB305W | PFA107 |
| | |
| PFA140 | PFA120 |
| | |
| PFA151 | PFA150 |
| | |
| PFB220C | |



Our code:
10891

SD1A404XB-GNR-W 4MP 4x Starlight IR PTZ AI Network Camera

- 1/2.8" 4Megapixel STARVIS™ CMOS
- Starlight technology
- Max. 25/30fps@4MP
- 4x optical zoom
- Face Detection, People Counting, Perimeter Protection
- IR distance up to 15m
- SMD Plus
- WIFI (support 2.4G & 5G)
- IP66, IK08



| MOUNTING ACCESSORIES | |
|----------------------|-----------------|
| Included: | |
| | |
| PFB303W | AC24V/3A |
| Optional: | |
| | |
| PFB300C | PFA140 |
| | |
| PFA150 | PFA120 |
| | |
| PFB303S | PFA151 |
| | |
| PFA111 | |



Our code:
10803

4K: SD8A840VI-HNI 40x Starlight IR PTZ Network Camera

- 1/2.8" 8-megapixel STARVIS™ CMOS
- Max. 25/30fps@1080P
- Powerful 40x optical zoom
- Starlight technology
- IR distance up to 450m
- Smart Wiper
- Support Hi-PoE
- IP67





Our code:
10836

2MP: SD49225T-HN-S2
25x Starlight IR PTZ Network Camera

- 1/2.8" 2Megapixel STARVIS™ CMOS
- Powerful 25x optical zoom
- Starlight technology
- Max.25/30fps@1080P
- IVS
- Support PoE+
- IR distance up to 100m
- IP66



| MOUNTING ACCESSORIES | |
|----------------------|----------------|
| Included: | |
| | |
| PFB305W | |
| Optional: | |
| | |
| PFA140 | PFA120 |
| | |
| PFB300C | PFB303S |
| | |
| PFA151 | PFA150 |
| | |
| DC12V/3A | PFA111 |



Our code:
10901

2MP: SD49225XA-HNR
16x Starlight IR PTZ Lite Network Camera

- 1/2.8" 2Megapixel STARVIS™ CMOS
- Powerful 16x optical zoom
- IR distance up to 100m
- Max. 25/30 fps@1080P
- IP66
- H.265



| MOUNTING ACCESSORIES | |
|----------------------|----------------|
| Included: | |
| | |
| PFB305W | |
| Optional: | |
| | |
| PFA140 | PFA120 |
| | |
| PFB300C | PFB303S |
| | |
| PFA151 | PFA150 |
| | |
| DC12V/3A | PFA111 |

Wizsense Series



Our code:
13186

TPC-DF1241P-D3F4

WizSense Thermal Network Eyeball Camera

- Uncooled VOx thermal sensor technology
- Athermalized lens (thermal camera), focus-free
- 1/2.7" 4Megapixel progressive scan CMOS
- Support ROI, motion detection, color palettes
- Smoking and call behaviour detection
- Support fire detection & alarm
- Built-in 1/1 alarm in/out
- Micro SD memory, IP67, PoE
- Smart linkage with strobe light & audio
- Dual image fusion (visible and thermal images)



Our code:
13199

TPC-BF1241P-D3F4

WizSense Thermal Network Bullet Camera

- Uncooled VOx thermal sensor technology
- Athermalized lens (thermal camera), focus-free
- 1/2.7" 4Megapixel progressive scan CMOS
- Wi-Fi Optional
- Support ROI, motion detection, color palettes
- Smoking and call behaviour detection
- Support fire detection & alarm
- Built-in 1/1 alarm in/out
- Micro SD memory, IP67, PoE
- Smart linkage with strobe light & audio
- Dual image fusion (visible and thermal images)



Thermography Series



Our code:
11407

TPC-SD2221-T

Thermal Network Hybrid Speed Dome Camera

- 256x192 VOx uncooled thermal sensor technology
- Athermalized lens (thermal camera), focus-free
- 1080P Full-HD image display
- Support ROI, motion detection, color palettes
- Support temperature measurement
- Support smoking detection
- Smart alarm linkage with white light & loudspeaker
- Built-in 2/1 alarm in/out
- Micro SD memory
- Support Fire detection & alarm



Our code:
11406

TPC-BF2221P-T

Thermal Network Hybrid Bullet Camera

- 256x192 VOx uncooled thermal sensor technology
- Athermalized lens (thermal camera), focus-free
- 1/2.8" 2Megapixel progressive scan CMOS
- Support ROI, motion detection, color palettes
- Support temperature measurement
- Support fire detection & alarm
- Built-in 2/2 alarm in/out
- Micro SD memory, IP67, PoE, ePOE



Dahua Thermal Body Temperature Measurement

Efficient, Visible & Real-time



Dahua Technology launches the industry's latest thermal camera, which is capable of highly accurate body temperature measurement $\pm 0.3^{\circ}\text{C}$ (with blackbody). With built-in AI algorithm, it can measure multiple persons from up to 3-meter distance, enabling fast and non-contact access.

SOLUTIONS

Basic solution



camera + blackbody
(a pc/laptop is needed to login to the cameras web server to configure the settings and get the live view of the temperature results.)

Economic solution



camera + blackbody + NVR5-I + DSS Express
(camera can do temperature measurement and NVR5-I can do mask detection, Max 4ch)

Standard solution





camera + blackbody + IVSS7-I + DSS Pro
(camera can do temperature measurement, IVSS7-I can do mask detection (Max 8ch) and IVSS7-I supports export the face report with temperature info)

RECOMMENDATION

| | | | | |
|---|---|--|---|---|
|  |  |  |  |  |
| DH-TPC-BF3221-T Our code: 11419 Thermal: 256*192, 7mm. Visible: 2MP, 8mm. White light and loudspeaker alarm. Temperature accuracy $\pm 0.3^{\circ}\text{C}$ | JQ-D70Z Our code: 11422 BlackBody Box for Thermal Camera. | NVR5-I TPC alarm event linkage Statistical report and export 4 Channels Mask detection 4 Channels Face recognition. | IVSS7-I TPC alarm event linkage Statistical report and export 8 Channels Mask detection 8 Channels Face recognition. | DSS Express/Pro Unified TPC device management Real-time temperature display Rich alarm linkage for TPC events Multiple clients login |

Accessories :

| | |
|---|---|
|  |  |
| VCT-999 Our code: 11420 Tripod Stand - thermal camera | RAW021-00 Our code: 11421 Bracket for Bull/Black Box to Tripod |



IVSS SERIES



256CH: IVSS7024DR-16I
4U 24HDD AI Network Video Recorder

- Industry embedded micro-controller
- Max 512Mbps incoming bandwidth
- 256-channel IP video access
- Up to 256-channel perimeter protection
- Up to 96-channel face recognition by device
- Up to 256-channel face recognition by camera
- Up to 64-channel Video Metadata
- Up to 50 face databases with 300,000 face pictures in total
- Supports RAID 0/1/5/6/10
- SAS3.0 for storage extension
- 3HDMI/1VGA video output
- Redundant power



Our code:
10497

256CH: IVSS7016-4I
3U 16HDD AI Network Video Recorder

- Industry embedded micro-controller
- Max 512Mbps incoming bandwidth
- 256-channel IP video access
- Up to 64-channel perimeter protection
- Up to 24-channel face recognition by device
- Up to 80-channel face recognition by camera
- Up to 16-channel Video Metadata
- Up to 50 face databases with 300,000 face pictures in total
- Supports RAID 0/1/5/6/10
- SAS3.0 for storage extension
- 3HDMI/1VGA video output



Our code:
10490



128CH: IVSS7008-1I
2U 8HDD AI Network Video Recorder

- Industry embedded micro-controller
- Max 400Mbps incoming bandwidth
- 128-channel IP video access
- Up to 16-channel perimeter protection
- Up to 6-channel face recognition by device
- Up to 20-channel face recognition by camera
- Up to 4-channel Video Metadata
- Up to 50 face databases with 300,000 face pictures in total
- Supports RAID 0/1/5/6/10
- SAS3.0 for storage extension
- 3HDMI/2VGA video output



Our code:
10498

5 SERIES



64CH: NVR5864-I
 32CH: NVR5832-I
2U AI Network Video Recorder

- 64 or 32 Channel IP video access
- Smart H.265+/H.265/Smart H.264+/H.264/MJPEG
- Up to 16 Channel perimeter protection
- Up to 4 Channel video stream face recognition
- Up to 24 face pictures /sec processing
- Up to 20 face databases with 100,000 face images in total



Our code:
 64CH **10497** 32CH **10496**

32CH: NVR5432-16P-I
 16CH: NVR5216-16P-I
1U 16PoE AI Network Video Recorder

- 16 or 32 Channel IP video access
- Smart H.265+/H.265/Smart H.264+/H.264/MJPEG
- Up to 16 Channel perimeter protection
- Up to 4 Channel video stream face recognition
- Up to 24 face pictures /sec processing
- Up to 20 face databases with 100,000 face images in total
- 1-8 PoE Ports support ePoE & EoC



Our code:
 32CH **10476** 16CH **10419**

2 SERIES



Available in non PoE



16CH: NVR2216-16P-I
1U 16PoE WizSense Network Video Recorder

- New 4.0 user interface
- Remote surveillance, live view and video play on mobile phone App
- Max. decoding capability: 4x1080P@30fps. Supports adaptive decoding
- Supports mainstream cameras of ONVIF and RTSP protocols
- H.264/H265/Smart H.264+/Smart H.265+/MJPEG, H.265 auto switch
- 1 VGA/1 HDMI simultaneous video output by default, the maximum resolution of HDMI is 4K; and non-simultaneous video output is also supported, the maximum resolution is 1080P
- 1-channel face detection and recognition (AI by NVR); or 2-channel perimeter detection (AI by NVR); or 4-channel SMD (AI by NVR); up to 10 face databases and 5,000 face images
- Security baseline 2.1



Our code:
16CH PoE 16CH Non PoE
10503

8CH: NVR2108HS-8P-I
Compact 1U 8PoE WizSense Network Video Recorder

- New 4.0 user interface
- Remote surveillance, live view and video play on mobile phone App
- Max. decoding capability: 4x1080P@30fps. Supports adaptive decoding
- Supports mainstream cameras of ONVIF and RTSP protocols
- H.264/H265/Smart H.264+/Smart H.265+/MJPEG, H.265 auto switch
- 1 VGA/1 HDMI simultaneous video output by default, the maximum resolution of HDMI is 4K; and non-simultaneous video output is also supported, the maximum resolution is 1080P
- 1-channel face detection and recognition (AI by NVR); or 2-channel perimeter detection (AI by NVR); or 4-channel SMD (AI by NVR); up to 10 face databases and 5,000 face images
- Security baseline 2.1



Our code:
8CH PoE
10501

6 SERIES



Our code:
128CH 10407
64CH 10406

128CH: NVR608-128-4KS2
64CH: NVR608-64-4KS2
Ultra 4K H.265 Network Video Recorder

- Intel Processor
- Max. 128 IP camera inputs
- 2HDMI/1VGA simultaneous video output
- 16 alarm input channel, 8 relay out channel
- 8 SATA III Ports, up to 8TB capacity for each HDD, 4 USB ports
- Max. 384Mbps incoming bandwidth
- Up to 12MP resolution for preview and playback
- Supports RAID 0/1/5/10
- Smart Tracking and Intelligent Video



Our code:
10405

NVR608-32-4KS2
32 Channel Ultra 4K H.265 Network Video Recorder

- Intel Processor
- Max. 32 IP camera inputs
- 2HDMI/1VGA simultaneous video output
- 16 alarm input channel, 8 relay out channel
- 8 SATA III Ports, up to 8TB capacity for each HDD, 4 USB ports
- Max. 384Mbps incoming bandwidth
- Up to 12MP resolution for preview and playback
- Supports RAID 0/1/5/10
- Smart Tracking and Intelligent Video



5 SERIES



Our code:

64CH 2U

10443

64CH 1.52U

10436

64CH 2U: NVR5864-4KS2

64CH 1.5U: NVR5464-4KS2

4K & H.265 Pro Network Video Recorder (V2.00)

- Smart H.265+/H.265/Smart H.264+/H.264/MJPEG
- Max 320Mbps Incoming Bandwidth
- Up to 12MP Resolution for Preview and Playback
- 2HDMI/2VGA simultaneous video output



Our code:

32H

10438 (PoE)

10435 (non PoE)

16CH

10437 (PoE)

10434 (non PoE)

32CH 1.5U: NVR5432-16P-4KS2E

16CH 1.5U: NVR5416-16P-4KS2E

16PoE 4K&H.265 Pro Network Video Recorder

- Smart H.265+/H.265/Smart H.264+/H.264/MJPEG
- Max. 320Mbps incoming bandwidth
- Up to 12MP resolution for preview and playback
- 2HDMI/2VGA simultaneous video output
- 1-8 PoE Ports support 800m ePoE & EoC



Our code:

32CH

10460 (non POE)

16CH

10431 (PoE)

10424 (non PoE)

8CH

10426 (PoE)

10423 (non PoE)

32CH Non PoE 1U: NVR5232-4KS2

16CH 16PoE 1U: NVR5216-16P-4KS2E

8CH 8PoE 1U: NVR5208-8P-4KS2E

4K & H.265 Pro Network Video Recorder

- Smart H.265+/H.265/Smart H.264+/H.264/MJPEG
- Max. 320Mbps incoming bandwidth
- Up to 12MP resolution for preview and playback
- HDMI/VGA simultaneous video output
- 4 alarm input channel, 2 relay out channel
- 2 SATA III Port, up to 10TB capacity for each HDD, 2 USB ports
- All PoE ports support ePoE & EoC





Best Seller

Our code:

10466 (PoE)
10462 (non PoE)

16CH: NVR4216-16P-4KS2/L
1U 16PoE 4K & H.265 Lite

- Smart H.265+/H.265/Smart H.264+/H.264
- Max. 200Mbps incoming bandwidth
- Up to 8MP resolution for preview and playback
- Up to 2ch@4K/8ch@1080P decoding
- HDMI/VGA simultaneous video output
- 2 SATA III Port, up to 6TB capacity for each HDD, 2 USB ports
- Supports IPC UPnP, 8PoE ports



Our code:

10459 (PoE)
10455 (non PoE)

8CH: NVR4108HS-8P-4KS2/L
Compact 1U 8PoE 4K & H.265 Lite

- Smart H.265+/H.265/Smart H.264+/H.264
- Max. 80Mbps incoming bandwidth
- Up to 8MP resolution for preview and playback
- Up to 2ch@4K/8ch@1080P decoding
- HDMI/VGA simultaneous video output
- 1 SATA III Port, up to 6TB capacity for each HDD, 2 USB ports
- Supports IPC UPnP, 8 PoE ports



Best Seller

Our code:

10457 (PoE)

4CH: NVR4104HS-P-4KS2/L
Compact 1U 4PoE 4K & H.265 Lite

- Smart H.265+/H.265/Smart H.264+/H.264
- Max. 80Mbps incoming bandwidth
- Up to 8MP resolution for preview and playback
- Up to 2ch@4K/8ch@1080P decoding
- HDMI/VGA simultaneous video output
- Supports IPC UPnP, 4PoE ports
- 1 SATA Port, Up to 6TB capacity for each HDD, 2 USB ports



Our code:

10447 (non PoE)

4CH: NVR4104-4KS2/L
Smart 1U 1HDD Network Video Recorder

- New 4.0 user interface, Security baseline 2.1
- H.264, H.265, Smart H.264+, and Smart H.265+. H.265 auto switch
- Max. decoding capability: 8 × 1080p@30 fps. Supports adaptive decoding
- Supports mainstream cameras of ONVIF and RTSP protocols
- P2P remote surveillance, video play on mobile device
- VGA/HDMI simultaneous video output, maximum resolution of HDMI is 4K
- AI by Camera: Face detection, perimeter protection, IVS, people counting, heat map, and SMD
- Supports remote configuration and management of IPC, such as setting parameters, getting information, and upgrading IPC of the same model in batches



Seagate SkyHawk Surveillance 3.5 Hard Drive

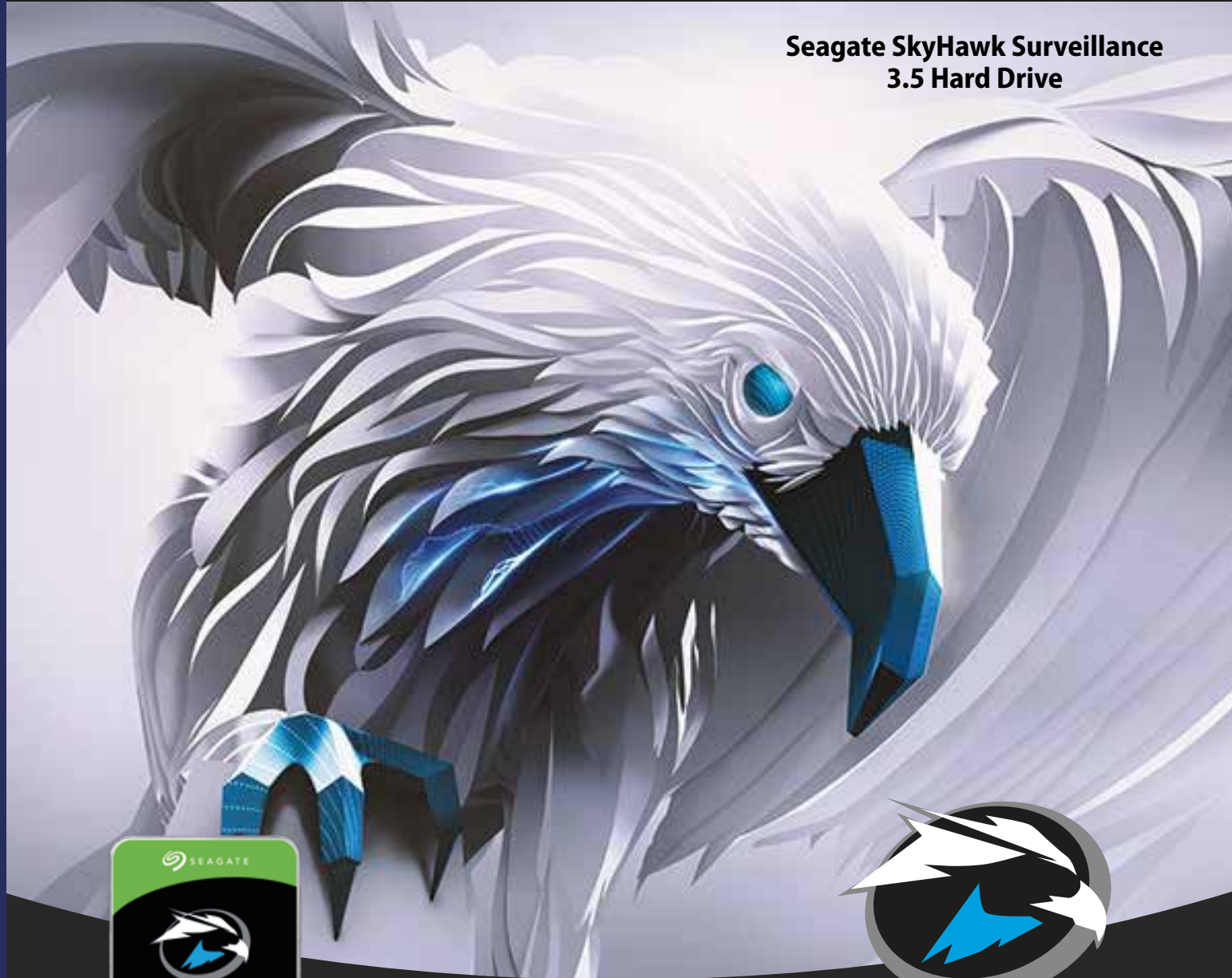

Best-Fit Applications:

- Network video recorders (NVR)
- Surveillance DVRs



SKYHAWK
SURVEILLANCE

OUR CODE

DESCRIPTION

| | |
|------|--------------------------------|
| 4352 | Seagate Sky Hawk CCTV HDD 1TB |
| 4353 | Seagate Sky Hawk CCTV HDD 2TB |
| 4354 | Seagate Sky Hawk CCTV HDD 3TB |
| 4355 | Seagate Sky Hawk CCTV HDD 4TB |
| 4356 | Seagate Sky Hawk CCTV HDD 6TB |
| 2594 | Seagate Sky Hawk CCTV HDD 8TB |
| 2604 | Seagate Sky Hawk CCTV HDD 10TB |

ImagePerfect™ firmware, SkyHawk Health Management, RV sensors built in, ATA streaming support, 1 M hours MTBF, 3-year limited warranty, Lower power consumption, Unparalleled data protection, Up to 10TB or over 2 000 hours of HD video storage



HDCVI Cameras & XVRs

ACTIVE DETERRENCE | TiOC | PRO SERIES | LITE SERIES | PoC SERIES | PIR & IoT | MICRO SIZE | PTZ | XVR

TiOC



TiOC

Also available in black

Our code:

4K (2.8mm)

10793

5MP (2.8mm)

10791

5MP BLACK (2.8mm)

10799

4K: HAC-ME1809HP-A-PV 2.8mm
5MP: HAC-ME1509HP-A-PV 2.8mm

HDCVI Full-Color Active Deterrence Fixed Eyeball

- Active deterrence with red blue light,
- Built-in mic
- Max. 30 fps@4K
- 2.8 mm fixed lens (3.6 mm optional)
- 40 m illumination distance
- IP67, 12V±30% DC
- 24/7 color imaging



| MOUNTING ACCESSORIES | |
|----------------------|----------|
| Optional: | |
| PFM321D | PFA137 |
| LR1002-1ET/1EC | PFB203W |
| PFB220C | PFA152-E |
| PFA130-E | PFA107 |
| ARA16 | ARA11 |
| | PFA137-B |

TiOC



Our code:

8MP

10792

5MP

10790

8MP: HAC-ME1809THP-A-PV 3.6mm
5MP: HAC-ME1509THP-A-PV 3.6mm

HDCVI Full-Color Active Deterrence Fixed Bullet

- 24/7 color imaging
- Active deterrence with red blue light,
- Built-in mic
- Max. 20 fps
- 3.6 mm fixed lens
- 40 m illumination distance
- IP67, 12V±30% DC



| MOUNTING ACCESSORIES | |
|----------------------|-----------|
| Optional: | |
| PFM321D | PFA137 |
| PFA13G | PFM800-4K |
| PFA130-E | PFA152-E |
| ARA16 | ARA11 |

Starlight



Best Seller

Our code:
10589

4K: HAC-HDW2802T-A Starlight HDCVI IR Eyeball Camera

- 1/2.7" 4-megapixel progressive scan CMOS
- Max. 30fps@4MP
- Built-in mic
- HD and SD output switchable
- 2.8mm (H: 97°, V: 52°) fixed lens
- Max. IR length 50m, Smart IR
- DWDR, Day/Night (ICR), 2DNR, AWB, AGC, BLC
- IP67, DC12V

Variants: 3.6mm (H: 76.4°, V: 41.6°) 6mm (H: 48.6°, V: 27.9°)



Our code:
10798

5MP: HAC-HDW2501TMP-A-S2 Starlight HDCVI Quick-to-install IR Eyeball Camera

- Max 25 fps@5MP (16:9 video output)
- Starlight, 120 dB true WDR, 3D NR
- CVI/CVBS/AHD/TVI switchable
- Quick-to-install eyeball saves installation time
- 2.8 mm fixed lens
- Built-in mic
- Max. IR length 60 m, Smart IR
- IP67, DC12V±30%



Our code:
4K
10597
5MP
10796

4K: HAC-HDBW2802RP-Z-DP 3.7-11mm 5MP: HAC-HDBW2501RP-Z-DP 2.7-13.5mm Starlight HDCVI IR Dome Camera

- Starlight, 120dB True WDR, 3DNR
- Max. 4K resolution/Max. 25 fps@5MP (16:9 video output)
- HD/SD switchable
- Audio in interface
- motorized lens
- Max. IR length 30m, Smart IR
- IP67, IK10, AC24V/DC12V±30%



Our code:
10797

5MP: HAC-HDW2501TP-Z-A-DP 2.7-13.5mm Starlight HDCVI IR Eyeball Camera

- Max. 25 fps@5MP (16:9 video output)
- Starlight, 120 dB true WDR, 3D NR
- CVI/CVBS/AHD/TVI switchable
- Built-in mic
- 2.7 mm-13.5 mm motorized lens
- Max. IR length 60 m, Smart IR
- IP67, 24V AC/12V DC

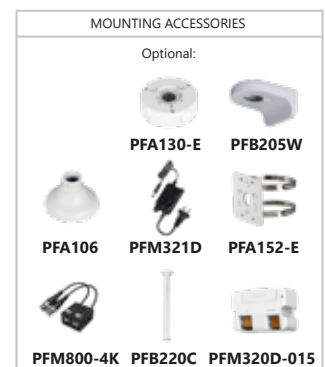

Starlight



Best Seller

Our code:

4K
10577
5MP
10571

4K: HAC-HFW2802T-A-I8 3.6mm
5MP: HAC-HFW2501TP-I8-A 3.6mm
Starlight HDCVI IR Bullet Camera

- Starlight, 120dB True WDR, 3DNR
- Max. 4K resolution or Max. 20fps@5MP
- HD/SD switchable
- Audio in interface, built-in mic
- 3.6mm fixed lens
- Max. IR length 80m, Smart IR
- IP67, DC12V±30%



Our code:

4K
10580
5MP
10795

4K: HAC-HFW2802T-Z-A-DP 3.7-11mm
5MP: HAC-HFW2501TU-Z-A-DP 2.7 mm-13.5 mm
Starlight HDCVI IR V/F Bullet Camera

- Starlight, 120dB True WDR, 3DNR
- Max. 4K resolution OR Max. 25 fps@5MP
- HD/SD switchable
- Audio in interface, built-in mic
- 3.7-11mm OR 2.7-13.5mm motorized lens
- Max. IR length 80m, Smart IR
- IP67, AC24V/DC12V±30%



HDCVI CAMERAS LITE SERIES

Full Colour



Best Seller

Also available in black

Our code:

5MP
10772
5MP BLACK
10785

5MP: HAC-HDW1509T(-A)-LED 2.8mm
Full-color Starlight HDCVI Eyeball

- 40 m LED distance
- Max. 20fps@5MP
- CVI/CVBS/AHD/TVI switchable
- Built-in mic (-A)
- 2.8 mm fixed lens
- IP67, 12V±30% DC





Full Colour



Our code:
10769

2MP: HAC-HDW1239T(-A)-LED 3.6mm Full-color Starlight HDCVI Eyeball

- 40m LED distance
- Max. 30fps@1080P
- CVI/CVBS/AHD/TVI switchable
- Built-in mic(-A)
- 3.6mm fixed lens
- IP67, 12V±30% DC



| MOUNTING ACCESSORIES | | |
|----------------------|--------------------|------------------|
| Optional: | | |
| | | |
| PFA130-E | PFB204W | PFA152-E |
| | | |
| PFM820 | PFB220C | PFM800-4K |
| | | |
| PFM800B-4K | PFM320D-015 | PFM300 |
| | | |
| PFM800-E | PFA151 | PFA106 |



Our code:
10773

5MP: HAC-HFW1509TP(-A)-LED 3.6mm Full-color HDCVI Bullet Camera

- Max 25 fps@5MP (16:9 video output)
- 120 dB true WDR, 3D NR
- 24/7 color imaging
- 20 m illumination distance
- CVI/CVBS/AHD/TVI switchable
- Built-in mic (-A)
- 3.6 mm fixed lens (2.8 mm optional)
- IP67, 12 V DC



| MOUNTING ACCESSORIES | |
|----------------------|-----------------|
| Optional: | |
| | |
| PFA151 | PFA152-E |
| | |
| PFM800-E | PFM321D |
| | |
| PFM820 | PFA130-E |
| | |
| | PFA134 |



Our code:
10551

2MP: HAC-HFW1239TPA 3.6mm Full-color HDCVI Bullet Camera

- 24/7 color imaging, Max. 30 fps@1080p
- 20 m illumination distance
- Super Adapt, 130 dB true WDR, 3D NR
- Built-in mic (-A)
- 3.6 mm fixed lens (2.8 mm optional)
- CVI/CVBS/AHD/TVI switchable
- IP67, DC 12 V



| MOUNTING ACCESSORIES | |
|----------------------|-----------------|
| Optional: | |
| | |
| PFA151 | PFA152-E |
| | |
| PFM800-E | PFM321D |
| | |
| PFM820 | PFA130-E |
| | |
| | PFA134 |

4K Turret/Eyeball



Our code:
10758

4K: HAC-HDBW1801E 2.8mm
HDCVI IR Dome Camera

- 120dB true WDR, 3D NR
- Max. 4K resolution
- CVI/CVBS/AHD/TVI switchable
- Fixed lens (2.8mm)
- Max. IR length 30m, smart IR
- IP67, IK10, 12V±30% DC



Our code:
10781

4K: HAC-HDW1800TLP-A 2.8mm
HDCVI IR Eyeball Camera

- Max. 4K resolution, real-time video transmission
- CVI/CVBS/AHD/TVI switchable
- Built-in mic (-A)
- Fixed lens 2.8mm
- Max. IR length 30m, Smart IR
- IP67, 12V±30%DC



Our code:
10757

4K: HAC-HDW1801EMP 3.6mm
HDCVI IR Eyeball Camera

- 120dB True WDR, 3D NR
- Max. 4K resolution
- CVI/CVBS/AHD/TVI switchable
- Built-in mic (-A)
- Fixed lens (3.6mm)
- Max. IR length 50m, Smart IR
- IP67, 12V±30%DC



4K Turret/Eyeball



Our code:
10759

4K: HAC-HDW1801TP-Z 2.7mm-13.5mm
HDCVI IR Eyeball Camera

- 120dB True WDR, 3DNR
- Max. 4K resolution
- CVI/CVBS/AHD/TVI switchable
- Built-in mic (-A)
- Auto focus, 2.7-13.5mm motorized lens
- Max. IR length 60m, smart IR
- IP67, 12V ±30% DC



4K Bullet



Our code:
10780

4K: HAC-HFW1800THP-I8 3.6mm
Real-time HDCVI IR Bullet Camera

- Max. 4K resolution, real-time video transmission
- CVI/CVBS/AHD/TVI switchable
- Fixed lens 3.6mm;6mm optional
- Max. IR length 80m, Smart IR
- IP67, 12V±30%DC



Our code:
10760

4K: HAC-HFW1801TL 3.6mm
HDCVI IR Bullet Camera

- 120dB True WDR, 3DNR
- Max. 4K resolution
- CVI/CVBS/AHD/TVI switchable
- Fixed lens (3.6mm)
- Max. IR length 80m, Smart IR
- IP67, 12V±30%DC



Our code:
10761

4K: HAC-HFW1801R-Z-IRE6 2.7mm - 13.5mm
HDCVI IR Bullet Camera

- 120dB true WDR, 3D NR
- Max. 4K resolution
- CVI/CVBS/AHD/TVI switchable
- Auto focus, 2.7-13.5mm motorized lens
- Built-in mic (-A)
- Max. IR length 60m, smart IR
- IP67, 12V ±30% DC





Available in black

Our code:

5MP (2.8mm)

10784

5MP (3.6mm)

10800

5MP BLACK (2.8mm)

10787

5MP: HAC-HDW1500TMP-A 2.8mm
5MP: HAC-HDW1500TMP-A 3.6mm
Starlight HDCVI IR Eyeball

- Max 25 fps@5MP (16:9 video output)
- CVI/CVBS/AHD/TVI switchable
- 2.8mm or 3.6 mm fixed lens
- Built-in mic
- Max. IR length 60 m, Smart IR
- IP67, 12V±30% DC

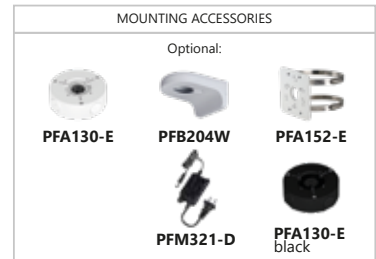

Our code:

2MP

10712 (2.8mm)

10713 (3.6mm)

HAC-HDW1200EM-A S4
2MP HDCVI IR Eyeball Camera

- 1/2.7" 2-megapixel progressive scan CMOS
- Max. 30fps@1080P
- Built-in mic
- HD and SD output switchable
- 2.8mm (H: 103°) fixed lens
- Max. IR length 50m, Smart IR
- IP67, DC12V

Variants: 3.6mm (H: 87.5°)



Our code:

10774

5MP: HAC-HDW1500TP-Z 2.7-12mm
HDCVI IR Eyeball Camera

- Max 30fps@1080P
- HD and SD output switchable
- 2.7-12mm motorized lens
- Max. IR length 60m, Smart IR
- IP67, DC12V



Our code:

10625

2MP: HAC-HDW1200R-VF 2.7-13.5mm
HDCVI IR Eyeball Camera

- Max 30fps@1080P
- HD and SD output switchable
- 2.7-13.5mm vari-focal lens
- Max. IR length 30m, Smart IR
- IP67, DC12V

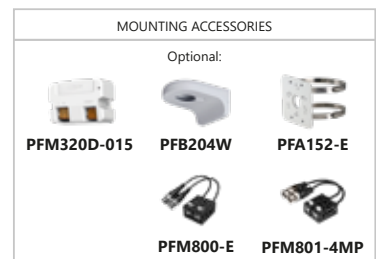



Our code:
5MP
10778

5MP: HAC-HFW1500TH-I8 3.6mm
Starlight HDCVI IR Bullet Camera

- Max 25fps@5MP (16:9 video output)
- CVI/CVBS/AHD/TVI switchable
- 3.6 mm fixed lens
- Max. IR length 80 m, Smart IR
- IP67, DC12V



Our code:
2MP
10685

2MP: HAC-HFW1200D-S4
HDCVI IR Bullet Camera

- Max 30fps@2MP
- HD and SD output switchable
- 3.6mm fixed lens
- Max. IR length 80m, Smart IR
- IP67, DC12V



Our code:
5MP
10775
2MP
10615

5MP: HAC-HFW1500R-Z-IRE6-A 2.7-12mm
2MP: HAC-HFW1200RP-Z-IRE6-S 2.7-12mm
HDCVI IR Bullet Camera

- Max 30fps@1080P or Max 25 fps@5MP (16:9 video output)
- HD and SD output switchable (2MP)
- or CVI/CVBS/AHD/TVI switchable (5MP)
- 2.7-12mm motorized lens
- Built-in mic(-A)
- Max. IR length 60m, Smart IR
- IP67, DC12V



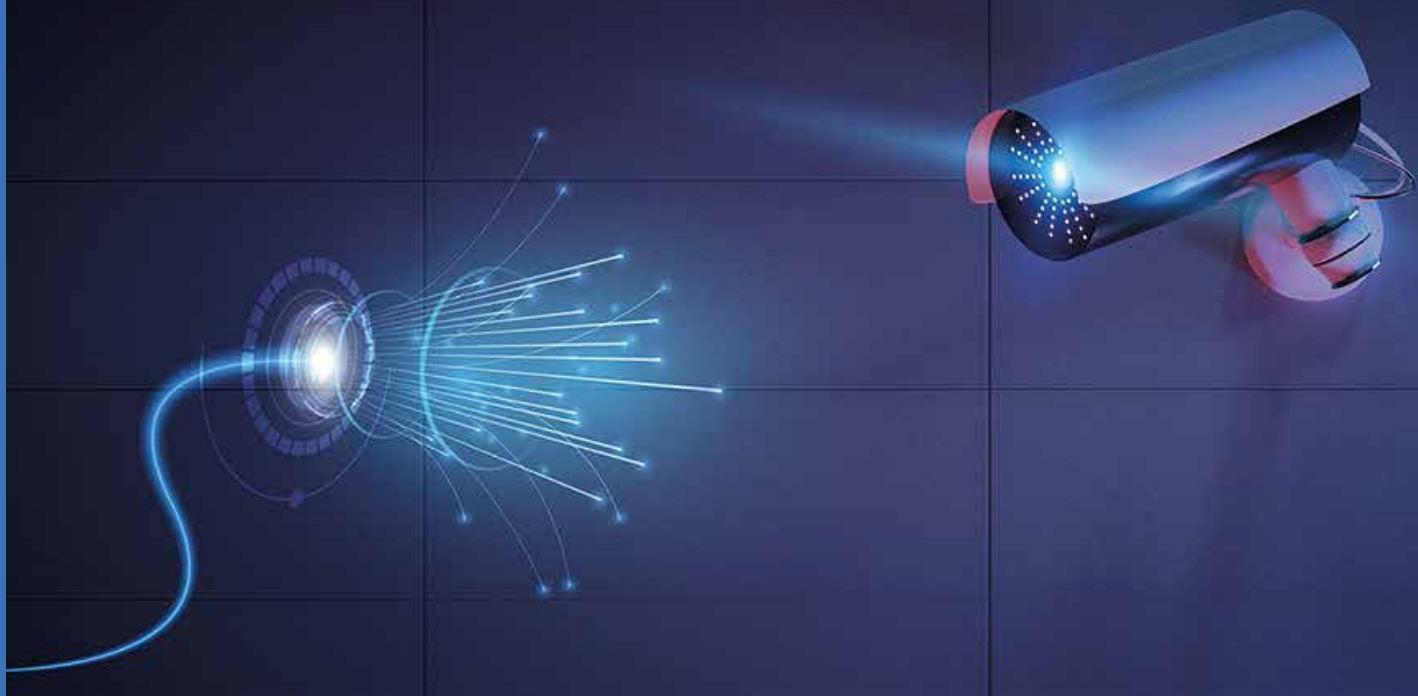

WANT TO TRY POC ?



Did you know you can power up your security camera by using Power Over Coax (PoC) without the need to use extra cables?

Non PoC:

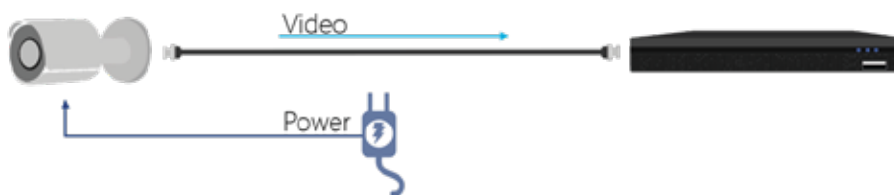

PoC:

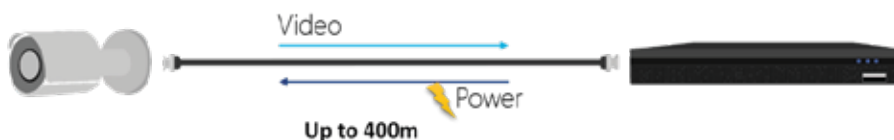

Power over Coax (PoC) transmits both video and electrical power over a single coaxial cable, eliminates separate camera power supplies. PoC technology further simplifies HDCVI system deployment, reducing time and cost. Long distance transmission capability guarantees up to 400m for 1080P and 300m for 4MP transmission.



Our code:
5MP

10766

5MP BLACK

10786

2MP

10717

5MP: HAC-HDW1500EM-A-POC
2MP: HAC-HDW1200EM-A-POC
HDCVI POC IR Eyeball Camera

- Max. 20fps@5MP, Max. 30fps@4MP/2MP
- Built-in mic
- HD and SD output switchable
- 2.8mm fixed lens
- Max. IR length 50m, Smart IR
- IP67, POC/DC12V

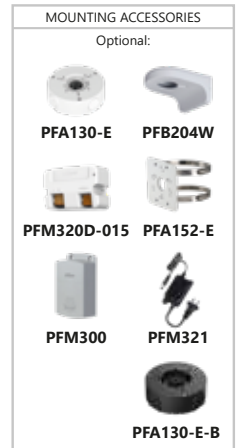

Our code:

10767

5MP: HAC-HDW1500T-Z-A-POC
HDCVI POC IR Eyeball Camera

- Max 20fps@5MP, Max 30fps@4MP
- HD and SD output switchable
- Built-in mic
- 2.7-12mm motorized lens
- Max. IR length 60m, Smart IR
- IP67, POC/DC12V



Our code:

10562

HAC-HDW2241T-Z-POC
2MP Starlight HDCVI POC IR Eyeball Camera

- Starlight, 120dB True WDR, 3DNR
- Max. 30fps@1080P
- HD/SD output switchable
- 2.7-13.5mm motorized lens
- Max. IR length 60m, Smart IR
- IP67, POC/DC12V±30%





LITE SERIES

Our code:

5MP 10770
2MP 10671

5MP: HAC-HFW1500T-POC
2MP: HAC-HFW1200T-POC
HDCVI POC IR Eyeball Camera

- Max. 20fps@5MP, Max. 30fps@4MP/2MP
- HD and SD output switchable
- 3.6mm fixed lens
- Max. IR length 30m, Smart IR
- IP67, POC/DC12V



LITE SERIES

Our code:

10762

5MP: HAC-HFW1500R-Z-IRE6-POC
HDCVI POC IR Eyeball Camera

- Max 20fps@5MP, Max 30fps@4MP
- HD and SD output switchable
- 2.7-12mm motorized lens
- Max. IR length 60m, Smart IR
- IP67, POC/DC12V

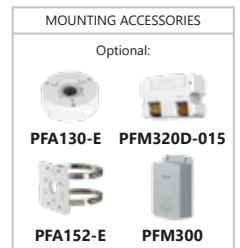

Our code:

10558

HAC-HFW2241T-Z-POC 2.7-13.5mm
2MP Starlight HDCVI POC IR Bullet Camera

- Starlight, 120dB True WDR, 3DNR
- Max. 30fps@1080P
- HD/SD switchable
- 2.7-13.5mm motorized lens
- Max. IR length 80m, Smart IR
- IP67, DC12V±30%

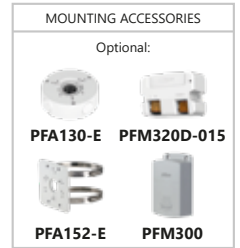



Our code:
10727

HAC-HUM3201B 2MP Starlight HDCVI Pinhole Camera

- Starlight, 120dB true WDR, 3DNR
- Max 30fp@1080P
- HD and SD output switchable
- 3.6mm fixed lens
- DC12Vr



Our code:
10738

HAC-HUM1220A-PIR 2MP HDCVI MotionEye Camera

- Max 30fps@1080P
- HD and SD output switchable
- 2.8mm fixed lens
- 12m/100° detecting range/angle
- Two level detection sensitivity adjustable
- Built-in tamper switch
- DC12V





Our code:
10904

2MP: SD49225-HC-LA1
25x Starlight IR PTZ HDCVI Camera

- 1/2.8" 2Megapixel STARVIS™ CMOS
- Powerful 25x optical zoom
- Starlight technology
- 120 dB true WDR, 3D DNR
- Max. 25/30 fps@1080P, 25/30/50/60 fps@720P
- IR distance up to 100 m
- IP66



| MOUNTING ACCESSORIES | | |
|----------------------|-----------------|----------------|
| Included: | | |
| | | |
| PFB305W | | |
| Optional: | | |
| | | |
| PFA111 | DC12V/3A | |
| | | |
| PFA140 | PFB300C | PFB303S |
| | | |
| PFA151 | PFA150 | PFA120 |



Best Seller

Our code:
10878

2MP: SD59225I-HC-S3
25x 5-inch Starlight IR HDCVI PTZ

- 1/2.8" 2-megapixel STARVIS™ CMOS
- 25X Optical Zoom with auto focus
- Starlight technology
- 25fps@1080P, 25/50fps@720P, switchable to standard definition
- True Day/Night (ICR), WDR(120dB), BLC, HLC, Ultra DNR
- IR distance up to 150m
- 300 x Presets, 5 x Patterns, 8 x Tours, Auto Pan, Auto Scan
- 2 x Alarm Input/1 x Alarm Output, Audio Input
- High Speed Pan/Tilt mechanism with up to 400o per second pan
- IP66
- AC 24V/3A power input



| MOUNTING ACCESSORIES | | |
|----------------------|----------------|-----------------|
| Included: | | |
| | | |
| PFB300S | PFA111 | DC12V/3A |
| Optional: | | |
| | | |
| PFA140 | PFB300C | PFB303S |
| | | |
| PFA151 | PFA150 | PFA120 |



Our code:
10884

2MP: SD52C225-HC-LA
25x Starlight PTZ HDCVI Camera

- 1/2.8" 2Megapixel STARVIS™ CMOS
- Powerful 25x optical zoom
- Starlight technology
- 120dB true WDR, 3D DNR
- Max. 25/30 fps@1080P, 25/30/50/60 fps@720P
- IK10

7 Series



4K ULTRA HD

Our code:
11136

16CH: XVR7416L-4K-I2

Penta-brid 4K 1.5U WizSense Digital Video Recorder

- H.265+/H.265 dual-stream video compression
- Supports HDCVI/AHD/TVI/CVBS/IP video inputs
- Max 32 channels IP camera inputs, each channel up to 12MP; Max 128 Mbps incoming bandwidth
- Up to 6 channels video stream (analog channel) perimeter protection
- Up to 16 channels video stream (analog channel) SMD plus
- Up to 6 channels video stream (analog channel) human face recognition
- IoT & POS functionalities



4K ULTRA HD

Our code:
11138

16CH: XVR7216AN-4K-I2

Penta-brid 4K 1U WizSense Digital Video Recorder

- H.265+/H.265 dual-stream video compression
- Supports HDCVI/AHD/TVI/CVBS/IP video inputs
- Max 32 channels IP camera inputs, each channel up to 8MP; Max 128 Mbps incoming bandwidth
- Up to 6 channels video stream (analog channel) perimeter protection
- Up to 16 channels video stream (analog channel) SMD plus
- Up to 6 channels video stream (analog channel) human face recognition
- IoT & POS functionalities



4K ULTRA HD

Our code:
8CH

11126

4CH

11120

8CH: XVR7108HE-4K-I2

4CH: XVR7104HE-4K-I2

Penta-brid 4K Mini 1U 1HDD WizSense Digital Video Recorder

- H.265+/H.265 dual-stream video compression
- Supports HDCVI/AHD/TVI/CVBS/IP video inputs
- Max 16 or 8 channels IP camera inputs, each channel up to 8MP; Max 128 Mbps incoming bandwidth
- Up to 2 channels video stream (analog channel) Perimeter Protection
- Up to 8 channels video stream (analog channel) SMD Plus
- Up to 2 channels video stream (analog channel) human face recognition
- IoT & POS functionalities



4K ULTRA HD

Best Seller

Our code:
16CH

11119

8CH

11118

16CH 2HDD: XVR7216A-4K-I

8CH 2HDD: XVR7208A-4K-I

Penta-brid 4K 1U Digital Video Recorder

- H.265+/H.265 dual-stream video compression
- Supports HDCVI/AHD/TVI/CVBS/IP video inputs
- Supports 16/32/8 channels of IPC access, each channel up to 8MP input;
- Max 64/128/32 Mbps Incoming Bandwidth
- IoT & POS functionalities
- Perimeter Protection and SMD Plus
- Up to 2 channels video stream(analog channel)human face recognition



5 Series



Our code:
11135

32CH: XVR5432L-4KL-I2

Penta-brid 4K-N/5MP 1.5U WizSense Digital Video Recorder

- H.265+/H.265 dual-stream video compression
- Supports HDCVI/AHD/TVI/CVBS/IP video inputs
- Max 32 channels IP camera inputs, each channel up to 12MP; Max 128 Mbps incoming bandwidth
- Up to 6 channels video stream (analog channel) perimeter protection
- Up to 32 channels video stream (analog channel) SMD plus
- Up to 6 channels video stream (analog channel) human face recognition
- IoT & POS functionalities



Our code:
11140

32CH: XVR5232AN-4KL-I2

Penta-brid 4K-N/5MP 1U WizSense Digital Video Recorder

- H.265+/H.265 dual-stream video compression
- Supports HDCVI/AHD/TVI/CVBS/IP video inputs
- Max 32 channels IP camera inputs, each channel up to 8MP; Max 128 Mbps incoming bandwidth
- Up to 6 channels video stream (analog channel) perimeter protection
- Up to 6 channels video stream (analog channel) SMD plus
- Up to 6 channels video stream (analog channel) human face recognition
- IoT & POS functionalities



Our code:
11139

32CH: XVR5232AN-I2

Penta-brid 5M-N/1080P 1U 2HDDs WizSense Digital Video Recorder

- H.265+/H.265 dual-stream video compression
- Supports HDCVI/AHD/TVI/CVBS/IP video inputs
- Max 32 channels IP camera inputs, each channel up to 6MP; Max 128 Mbps incoming bandwidth
- Up to 2 channels video stream (analog channel) Perimeter Protection
- Up to 16 channels video stream (analog channel) SMD Plus
- Up to 2 channels video stream (analog channel) human face recognition
- IoT & POS functionalities



Our code:
11128

16CH: XVR5216AN-4KL-I2

Penta-brid 4K-N/5MP 1U 2HDDs WizSense Digital Video Recorder

- H.265+/H.265 dual-stream video compression
- Supports HDCVI/AHD/TVI/CVBS/IP video inputs
- Max 32 channels IP camera inputs, each channel up to 8MP; Max 128 Mbps incoming bandwidth
- Up to 2 channels video stream (analog channel) Perimeter Protection
- Up to 16 channels video stream (analog channel) SMD Plus
- Up to 2 channels video stream (analog channel) human face recognition
- IoT & POS functionalities



5 Series



UP TO 5MP

Our code:
11134

16CH: XVR5216AN-I2

Penta-brid 5M-N/1080P 1U 2HDDs WizSense Digital Video Recorder

- H.265+/H.265 dual-stream video compression
- Supports HDCVI/AHD/TVI/CVBS/IP video inputs
- Max 24 channels IP camera inputs, each channel up to 6MP; Max 128 Mbps incoming bandwidth
- Up to 2 channels video stream (analog channel) Perimeter Protection
- Up to 16 channels video stream (analog channel) SMD Plus
- Up to 2 channels video stream (analog channel) human face recognition
- IoT & POS functionalities



UP TO 5MP

Our code:
11132

16CH: XVR5116H-I2

Penta-brid 5M-N/1080P Mini 1U 1HDD WizSense Digital Video Recorder

- H.265+/H.265 dual-stream video compression
- Supports HDCVI/AHD/TVI/CVBS/IP video inputs
- Max 24 channels IP camera inputs, each channel up to 6MP; Max 128 Mbps incoming bandwidth
- Up to 2 channels video stream (analog channel) Perimeter Protection
- Up to 16 channels video stream (analog channel) SMD Plus
- Up to 2 channels video stream (analog channel) human face recognition
- IoT & POS functionalities



4K ULTRA HD

Our code:
11127

8CH: XVR5108HS-4KL-I2

Penta-brid 4K-N/5MP Compact 1U 1HDD WizSense Digital Video Recorder

- H.265+/H.265 dual-stream video compression
- Supports HDCVI/AHD/TVI/CVBS/IP video inputs
- Max 16 channels IP camera inputs, each channel up to 8MP; Max 128 Mbps incoming bandwidth
- Up to 2 channels video stream (analog channel) Perimeter Protection
- Up to 8 channels video stream (analog channel) SMD Plus
- Up to 2 channels video stream (analog channel) human face recognition
- IoT & POS functionalities



5 Series



Our code:
11131

8CH: XVR5108HS-I2

Penta-brid 5M-N/1080P Compact 1U 1HDD WizSense Digital Video Recorder

- H.265+/H.265 dual-stream video compression
- Supports HDCVI/AHD/TVI/CVBS/IP video inputs
- Max 12 channels IP camera inputs, each channel up to 6MP; Max 64 Mbps incoming bandwidth
- Up to 2 channels video stream (analog channel) Perimeter Protection
- Up to 8 channels video stream (analog channel) SMD Plus
- Up to 2 channels video stream (analog channel) human face recognition
- IoT & POS functionalities



Our code:
11133

4CH: XVR5104HS-4KL-I2

Penta-brid 4K-N/5MP Compact 1U 1HDD WizSense Digital Video Recorder

- H.265+/H.265 dual-stream video compression
- Supports HDCVI/AHD/TVI/CVBS/IP video inputs
- Max 8 channels IP camera inputs, each channel up to 8MP; Max 64 Mbps incoming bandwidth
- Up to 2 channels video stream (analog channel) Perimeter Protection
- Up to 4 channels video stream (analog channel) SMD Plus
- Up to 2 channels video stream (analog channel) human face recognition
- IoT & POS functionalities



Our code:
11130

4CH: XVR5104HS-I2

Penta-brid 5M-N/1080P Compact 1U 1HDD WizSense Digital Video Recorder

- H.265+/H.265 dual-stream video compression
- Supports HDCVI/AHD/TVI/CVBS/IP video inputs
- Max 6 channels IP camera inputs, each channel up to 6MP; Max 32 Mbps incoming bandwidth
- Up to 2 channels video stream (analog channel) Perimeter Protection
- Up to 4 channels video stream (analog channel) SMD Plus
- Up to 1 channel video stream (analog channel) human face recognition
- IoT & POS functionalities





4K ULTRA HD

Our code:
11048

XVR5216AN-4KL-X-16P
16 Channel Penta-brid 4K PoC 1U DVR

- H.265+/H.265 dual-stream video compression
- Supports HDCVI/AHD/TVI/CVBS/IP video inputs
- Max. 24 channels IP camera inputs, each channel up to 8MP
- Max. 96Mbps incoming bandwidth
- Recording: 4K (1-7fps), 5MP (1-12fps), 4MP/3MP (1-15fps), 1080P/720P (1-25fps) per channel
- Total 96W output power consumption (supports 8x fixed lens PoC camera or 4x motorised lens PoC camera), max. 300m@4mp, 400m@1080P transmission over RG59
- Audio In/Out: 1/1, RCA
- 2 SATA Port, each HDD up to 10TB capacity
- DC54V
- 1U, 375mm×287mm×53mm



4K ULTRA HD

Our code:
11037

XVR5108H-4KL-X-8P
8 Channel Penta-brid 4K Mini 1U DVR

- H.265+/H.265 dual-stream video compression
- Supports HDCVI/AHD/TVI/CVBS/IP video inputs
- Max 12 channels IP camera inputs, each channel up to 8MP; Max 48Mbps incoming bandwidth
- Smart Search and Intelligent Video System
- Total 48W output power consumption; Max supports 8 channels Lite series PoC cameras inputs or 4 channels Pro series PoC cameras inputs.



UP TO 5MP

Our code:
11124

XVR5104H-X-4P
4 Channel Penta-brid 1080P Mini 1U DVR

- H.265+/H.265 dual-stream video compression
- Supports HDCVI/AHD/TVI/CVBS/IP video inputs
- Max 6/12 channels IP camera inputs, each channel up to 6MP;
- Supports SMD, human face detection, IVS
- All-channel support HDCVI PoC AT & AF camera





EZ Series Surveillance Made Simple

EASY AND AFFORDABLE IP SOLUTION

Powered by Dahua

EZ-IP doesn't have to mean complex and costly.

It delivers entry level IP products with outstanding performance and simplicity.

It is perfect for small to medium size applications like home/residential security, small retail shops, and other typical SMB applications. At the same time, EZ-IP offers a perfect alternative to migrate from analog to an IP system with its easy-to-use nature and cost effectiveness.

It includes IP camera and NVR products that support real-time monitoring, video storage, and playback.

EZ-IP products are fully in line with Dahua's quality. Stable and reliable components are utilized and various tests such as anti-vibration, water resistance, and aging tests are performed to ensure Dahua quality standards.



NVR RECORDERS

4CH: NVR1B04HC-4P/E

8CH: NVR1B08HS-8P/E

Compact 1U 8PoE H.265 Network Video Recorder

- H.265+/H.264+ codec decoding
- Max 40Mbps/20Mbps incoming/outgoing bandwidth
- Max 4 or 8 channel IP camera inputs
- Up to 6MP resolution preview&playback
- Up to 1ch@6MP/4ch@1080P 25fps decoding
- HDMI/VGA simultaneous video output
- Support IPC UPnP, 4PoE ports or 8PoE ports



Our code:

4CH

20060

8CH

20061

DOME CAMERAS



2MP: IPC-T1B20-L

4MP: IPC-T1B40

IR Turret Fixed Network Camera

- 1/2.7" 2Megapixel or 1/3" 4Megapixel progressive CMOS
- H.265+ & H.265 dual-stream encoding
- 20fps@1080P(1920×1080) & 25/30fps@1.3MP(1280×960) or 20fps@4M(2560×1440) & 25/30fps@3M(2304×1296)
- DWDR, Day/Night(ICR), 3DNR, AWB, AGC, BLC
- Multiple network monitoring: Web viewer, CMS(DSS/PSS) & DMSS
- 2.8 mm fixed lens (3.6mm optional)
- Max IR LEDs Length 30m
- IP67, PoE

Our code:

2MP

20050

4MP

20055



2MP: IPC-T2B20P-L-ZS

4MP: IPC-T2B40P-ZS

IR Turret Varifocal Network Camera

- 1/2.7" 2Megapixel or 1/3" 4Megapixel progressive CMOS
- H.265+ & H.265 dual-stream encoding
- 20fps@1080P(1920×1080) or 20fps@4M(2560×1440) & 25/30fps@3M(2304×1296)
- DWDR, Day/Night(ICR), 3DNR, AWB, AGC, BLC
- Multiple network monitoring: Web viewer, CMS(DSS/PSS) & DMSS
- 2.8~12mm varifocal lens
- Max IR LEDs Length 40m
- Micro SD card memory, IP67, PoE

Our code:

2MP

20052

4MP

20057

BULLET CAMERAS



2MP: IPC-B1B20-L

4MP: IPC-B1B40

IR Mini-Bullet Network Camera

- 1/2.7" 2Megapixel or 1/3" 4Megapixel progressive CMOS
- H.265+ & H.265 dual-stream encoding
- 20fps@1080P(1920×1080) & 25/30fps@1.3MP(1280×960) or 20fps@4M(2560×1440) & 25/30fps@3M(2304×1296)
- DWDR, Day/Night(ICR), 3DNR, AWB, AGC, BLC
- Multiple network monitoring: Web viewer, CMS(DSS/PSS) & DMSS
- 3.6mm fixed lens (2.8mm optional)
- Max IR LEDs Length 30m
- IP67, PoE

Our code:

2MP

20053

4MP

20058



4MP: IPC-B2B40-ZS

IR Mini-Bullet Network Camera

- 1/3" 4Megapixel progressive CMOS
- H.265+ & H.265 dual-stream encoding
- 20fps@4M(2560×1440) & 25/30fps@3M(2304×1296)
- DWDR, Day/Night(ICR), 3DNR, AWB, AGC, BLC
- Multiple network monitoring: Web viewer, CMS(DSS/PSS) & DMSS
- 2.8~12mm varifocal lens
- Max IR LEDs Length 40m
- Micro SD card memory, IP67, PoE

Our code:

20059

HDCVI 4 CHANNEL CCTV KIT

| OUR CODE | MODEL | DESCRIPTION |
|----------|------------------|--|
| 20009 | XVR1B04H | 1 x 4 Channel DVR with 1TB HDD |
| 20000 | HAC-T2A21P-0280B | 4 x 2MP HDCVI IR Eyeball Camera 2.8mm |
| 3520 | 5C_BNCDC20M | 4 x BNC & Power lead 20M |
| 3544 | 5A_PS5_CAM | 1 x 12V 5A power supply |
| 3674 | | 1 x 4 way DC Splitter Cable |
| 4352 | WD10PURZ | 1 x WD Purple or Skyhawk 1TB CCTV hard drive |



Part number for kit : DH-4KITHDCVI / Our code : 20012

| OUR CODE | MODEL | DESCRIPTION |
|----------|-------|-------------|
|----------|-------|-------------|

XVR RECORDERS

| | | |
|-------|----------|---|
| 20009 | XVR1B04H | 4 Channel Penta-brid 4M-N/1080P Cooper 1U Digital Video Recorder |
| 20010 | XVR1B08H | 8 Channel Penta-brid 4M-N/1080P Cooper 1U Digital Video Recorder |
| 20011 | XVR1B16H | 16 Channel Penta-brid 4M-N/1080P Cooper 1U Digital Video Recorder |

DOME CAMERAS

| | | |
|-------|--------------------|-----------------------------------|
| 20000 | HAC-T2A21P-0280B | 2MP HDCVI IR Eyeball Camera 2.8mm |
| 20004 | HAC-T2A51 | 5MP HDCVI IR Eyeball Camera 2.8mm |
| 20006 | HAC-T3A41P-VF-2712 | 4MP Varifocal Focal IR Dome |

Bases:



BULLET CAMERAS

| | | |
|-------|--------------------|---------------------------|
| 20003 | HAC-B2A21P-0360B | 2MP HDCVI IR Bullet 3.6mm |
| 20007 | HAC-B2A41P-0360B | 4MP HDCVI IR Bullet 3.6mm |
| 20008 | HAC-B4A41P-VF-2712 | 4MP Varifocal IR Bullet |

Bases:

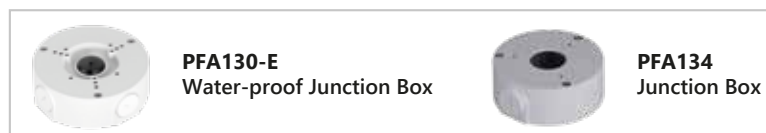



Display & Transmission

MONITORS | DISPLAY SOLUTIONS | PoE SWITCHES | ePoE SWITCHES |

Lite Series



LM22-B211
21.5" FHD Monitor

- Narrow bezel, elegant appearance;
- 178°H/178°V extra-wide viewing angle for overall viewing performance;
- High fidelity digital processing for a brilliant and vivid video;
- Support multiple signal inputs including HDMI and VGA;
- Low energy consumption, long service life;
- Support 24x7 continuous operation, high reliability.



Our code:
12139



DHL24-F600
23.8" FHD Monitor

- Industrial level LCD panel, suitable for continuous 24/7 operation
- Physical resolution of 1920×1080
- High fidelity digital processing for a brilliant and vivid video
- Built-in speakers
- Good compatibility with DVRs and NVRs
- Low energy consumption, long service life



Our code:
12140



DHL32-F600
32" FHD Monitor

- Industrial level LCD panel, suitable for continuous 24/7 operation
- Physical resolution of 1920×1080
- High fidelity digital processing for a brilliant and vivid video
- 5ms fast response time for no motion blur, judder or ghosting
- Built-in speakers



Our code:
12109



DHL43-F600
43" FHD Monitor

- Industrial level LCD panel, suitable for continuous 24/7 operation
- Physical resolution of 1920×1080
- High fidelity digital processing for a brilliant and vivid video
- 5ms fast response time for no motion blur, judder or ghosting
- Built-in speakers



Our code:
12112

UHD 4K Series



Best Seller

LM28-F401
28" UHD Monitor

- Industrial level LCD panel, suitable for continuous 24/7 operation
- Physical resolution of 3840x2160
- High fidelity digital processing for a brilliant and vivid video
- 5ms fast response time for no motion blur, judder or ghosting
- Built-in speakers

LM43-F410
43" UHD LED Monitor

- Built-in 3D COMB filter and 3D noise reduction
- 8.5ms response time for no motion blur, judder or ghosting
- 1.07G colors, for a realistic and immersive visual experience
- High fidelity digital processing for a brilliant and vivid video
- 178°/178° extra-wide viewing angle for overall viewing performance
- Professional thermal design to extend equipment lifespan
- Built-in power, low energy consumption



Our code:
12113

Our code:
12102



LM50-F410
50" UHD LED Monitor

- Built-in 3D COMB filter and 3D noise reduction
- 8.5ms response time for no motion blur, judder or ghosting
- 1.07G colors, for a realistic and immersive visual experience
- High fidelity digital processing for a brilliant and vivid video
- 178°/178° extra-wide viewing angle for overall viewing performance
- Professional thermal design to extend equipment lifespan
- Built-in power, low energy consumption

LM55-F410
55" UHD LED Monitor

- Built-in 3D COMB filter and 3D noise reduction
- 8ms response time for no motion blur, judder or ghosting
- 1.07G colors, for a realistic and immersive visual experience
- High fidelity digital processing for a brilliant and vivid video
- 178°/178° extra-wide viewing angle for overall viewing performance
- Professional thermal design to extend equipment lifespan
- Built-in power, low energy consumption



Our code:
12135

Our code:
12134

Test Monitors



PFM906
7" CCTV 4K IPC Test Monitor

- 7" IPS HD retina capacitive touch screen(1920*1200);
- Support IP, HDCVI/AHD/TVI/CVBS, SDI;
- Support HDMI Input/Output;
- Support PoE, DC12V 2A and USB5V 2A power out;
- Build-in 37Wh big capacity polymer lithium ion battery, which can last 10 hours for normal use;
- Support TDR(network cable/coaxial cable), UTP cable tester and hunting, optical cable VFL;
- Support digital multi-meter function;
- Support optical power meter test function

Our code:
12107



PFM904
4.3" CCTV 4K Test Monitor

- HDCVI/AHD/TVI/CVBS video display control
- 12V/1A DC power supply for the camera
- Support RS-485 control
- Support audio test
- Charge through USB connector
- Compact and portable, desinged with a removable wrist strap
- Replaceable 18650 lithium ion battery

Our code:
12104

DAHUA DISPLAY SOLUTION

• LCD DIGITAL SIGNAGE:

Indoor Series



Treasure Series



Outdoor Series



Media Player :
Our code: 13099



The Dahua Media player is android based and is perfect for using as a digital signage player to display content on any size screen!

• LCD VIDEO WALLS:

High quality LCD Video Walls available in different sizes and bezel options
Bezel options available from 0.88mm to 3.5mm



• LED DISPLAYS

Dahua offer a wide range of high quality LED Displays for all types of applications.

The range covers indoor and outdoor displays perfect for advertising in the retail sector to commercial displays

IF YOU WOULD LIKE TO
KNOW MORE ABOUT THE
RANGE PLEASE GIVE US A
CALL TO TALK TO OUR
SALES TEAM

**Come and see in
our showroom:
We now have on
display from their
indoor fine pixel
range a 3.6 meters
by 1.4 meters
1.5-55 Display !**

KD ELECTRONICS Mobile App

Our online store
made simpler,
Download now!

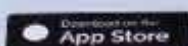

Keyboard



Our code:
13166

NKB1000 Network Keyboard

- Keyboard to control
 - Dahua High Speed Dome
 - Dahua Standalone DVR
 - Dahua Network High Speed Dome
- Network Video Server Connection
- RS485, RS422, USB, RS232 & Network Functions
- Three-dimensional joystick control of PTZ Functions
- Preset Position, Auto Scan, Auto Pan, Auto Tour & Pattern Auxiliary Functions
- Auxiliary Functions
- On-Screen Menu & User Operation Procedure Tips
- Connect to SmartPSS via USB



Our code:
13183

NKB5000 HD Network Control Keyboard

- Keyboard to control
 - Dahua High Speed Dome
 - Dahua Standalone DVR
 - Central Management Platform
 - Network Video Server
- RS232, RS485 & network connections (WLAN)
- Four dimensional joystick control of PTZ functions
- Support 4K decoding live view
- Support 4CH HDMI output
- Support snapshot and recording to U-disk
- Support Video-Wall display control
- Preset Position, Auto Scan, Auto Pan, Auto Tour & Pattern Control

PoE 10/100



Our code:
12080

PFS3005-4ET-60 5-Port Unmanaged Desktop Switch with 4-Port PoE

- Intelligent PoE
- Hi-PoE 60W (orange port)
- 8-pin assignment PoE power supply
- Long distance PoE
- PoE watchdog
- Wide working temperature



Our code:
12126

PFS3006-4ET-60 6-Port Unmanaged Desktop Switch with 4-Port PoE 2.0

- Layer two commercial switch
- Supports IEEE802.3, IEEE802.3u, IEEE802.3ab and IEEE802.3x standards
- MDI/MDIX self-adaptation
- RJ-45 port supports 10/100 Mbps self-adaptation, and conforms to 802.3at, and 802.3af power supply standards
- Port 1 supports Hi-PoE 60W power supply
- 250 m PoE power supply
- Wall mounting and mechanical anti-theft
- 53V DC power supply
- Supports PoE watchdog



Our code:
12082

PFS3010-8ET-96 8-Port PoE Switch (Unmanaged)

- Layer two commercial switch
- Supports PoE power management
- Supports wall-mount installation
- Supports anti-theft lock hole
- MAC auto learning and aging, MAC address capacity is 16K
- Supports IEEE802.3, IEEE802.3u and IEEE802.3X standards
- RJ45 port supports 10/100 Mbps self-adaptation
- Supports 250 meters long distance PoE transmission
- Conforms to IEEE802.3af and IEEE802.3at power supply standard. Port 1 supports Hi-PoE 60W power supply



PFS3117-16ET-135 16-Port FE PoE+ 1-Port Gigabit Combo PoE Switch

- Compliant IEEE 802.3, IEEE 802.3u, IEEE802.3ab, IEEE802.3x standards
- Supports IEEE802.3af, IEEE802.3at, Hi-PoE standards
- Supports normal working mode, port isolation (VLAN) mode, monitoring mode, network extend mode.
- Supports Store-and-Forward
- 16*10/100Mbps ports, 1*Gigabit Combo port, support port auto flipping (Auto MDI / MDIX)
- Port 1-2 support the maximum power of 60W, PoE output total power up to 135W
- Supports IEEE802.3x flow control for Full-duplex Mode and backpressure for Half-duplex Mode
- 4K entry MAC address table with auto-learning and auto-aging
- LED indicators for monitoring power, link and activity

Our code:
12084



PFS3010-8GT-96 24-Port FE PoE+ 1-Port Gigabit Combo PoE Switch

- Compliant IEEE 802.3, IEEE 802.3u, IEEE802.3ab, IEEE802.3x standards
- Supports IEEE802.3af, IEEE802.3at, Hi-PoE standards
- Supports normal working mode, port isolation (VLAN) mode, monitoring mode, network extend mode.
- Supports Store-and-Forward
- 24*10/100Mbps ports, 1*Gigabit Combo port, support port auto flipping (Auto MDI / MDIX)
- Port 1-2 support the maximum power of 60W, PoE output total power up to 190W
- Supports IEEE802.3x flow control for Full-duplex Mode and backpressure for Half-duplex Mode
- 4K entry MAC address table with auto-learning and auto-aging
- LED indicators for monitoring power, link and activity

Our code:
12087

Gigabit PoE 10/100/1000



PFS3006-4GT-60 6-Port Unmanaged Desktop Switch with 4-Port PoE

- Intelligent PoE
- Hi-PoE 60W (orange port)
- Long distance PoE
- PoE watchdog
- All-giga ports
- Wide working temperature

Our code:

12136



PFS3010-8GT-96 10-Port Gigabit Unmanaged Desktop Switch with 8-Port PoE

- Intelligent PoE
- 8-pin assignment PoE power supply
- Long distance PoE
- PoE watchdog
- BT 90W
- All-giga ports
- Wide working temperature

Our code:

12127



PFS3220-16GT-240 16-Port Gigabit PoE Switch

- Intelligent PoE
- Hi-PoE 60W (orange port)
- Long distance PoE
- PoE watchdog
- All-giga ports
- Wide working temperature

Our code:

12128



PFS3228-24GT-360 24-Port Gigabit PoE Switch

- Intelligent PoE
- Red Port Supports BT 90W
- All-giga Ports
- Smooth Transmission
- Wide Working Temperature: -10°C to 55°C (14°F to 131°F)
- Plug and Play

Our code:

12129

Managed PoE



Our code:

12138

PFS4212-8GT-96 12-Port Managed Desktop Gigabit Switch with 8-Port PoE

- All-gigabit port design
- Supports IEEE802.3af, IEEE802.3at, Hi-PoE and IEEE802.3bt (red port) standards
- 250 m long-distance PoE transmission (10 Mbps)
- PoE Watchdog
- Supports STP, RSTP, and MSTP
- IEEE802.1Q-based VLAN configuration
- Manual link aggregation and static LACP
- Desktop mount and wall mount



PFS4218-16ET-240 16-port 100 Mbps + 2-port Gigabit Managed PoE Switch

- Intelligent PoE
- Red port supports 90W IEEE802.3bt
- Web management with friendly interface and easy operation
- 250 m long distance PoE transmission
- PoE watchdog
- Plug and play

Our code:

12133



PFS4226-24ET-360 24-port 100 Mbps + 2-port Gigabit Managed PoE Switch

- Intelligent PoE
- Red port supports 90W IEEE802.3bt
- Web management with friendly interface and easy operation
- 250 m long distance PoE transmission
- PoE watchdog
- Plug and play

Our code:

12132

ePoE switches



Our code:
12083

LR2110-8ET-120 8-Port ePoE Switch

- Supports long distance PoE transmission up to 800m with ePoE technology
- Layer-two ePoE switch
- MAC auto study and aging, MAC address list capacity is 8K
- Conform IEEE802.3, IEEE802.3u, IEEE802.3ab/z and IEEE802.3X standards
- Supports IEEE802.3af, IEEE802.3at, Hi-PoE standard
- Industrial wide temperature design
- Port indicator light is to display the status of current transmission mode for the port, which includes IEEE, E100 and E10



Our code:
12085

LR2218-16ET-240 16-Port PoE Switch with 8-Port ePoE

- Supports long distance PoE transmission up to 800m with ePoE technology of Dahua
- Layer-two web managed ePoE switch
- Port 1-8 support three self-adaptive transmission modes which are IEEE, E100 and E10
- Port 1-8 support both twisted-pair transmission and coaxial cable transmission
- Support web management: port management, 802.1Q VLAN, STP/RSTP, LACP, 802.1X, QoS
- Support PoE management, Green PoE, Legacy Support
- Conform IEEE802.3, IEEE802.3u, IEEE802.3ab/z and IEEE802.3X standards



Our code:
12088

LR2226-24ET-360 24-Port PoE Switch with 8-Port ePoE

- Supports long distance PoE transmission up to 800m with ePoE technology of Dahua
- Layer-two web managed ePoE switch
- Port 1-8 support three self-adaptive transmission modes which are IEEE, E100 and E10
- Port 1-8 support both twisted-pair transmission and coaxial cable transmission
- Support web management: port management, 802.1Q VLAN, STP/RSTP, LACP, 802.1X, QoS
- Support PoE management, Green PoE, Legacy Support
- Conform IEEE802.3, IEEE802.3u, IEEE802.3ab/z and IEEE802.3X standards

Gigabit Managed



Our code:
12098

PFS4207-4GT-DP

7-port Gigabit Industrial Switch with 4-port PoE (Managed)

- All-gigabit port design
- Supports IEEE802.3af, IEEE802.3at, Hi-PoE and IEEE802.3bt(red port) standards
- 250 m long-distance PoE transmission (10 Mbps)
- PoE Watchdog
- Supports STP, RSTP, and MSTP
- IEEE802.1Q-based VLAN configuration
- Manual link aggregation and static LACP
- Wide voltage design (9 V–57 V)
- Desktop mount and DIN-rail mount



Our code:
12099

PFS4210-8GT-DP

10-port Gigabit Industrial Switch with 8-port PoE (Managed)

- All-gigabit port design
- Supports IEEE802.3af, IEEE802.3at, Hi-PoE and IEEE802.3bt(red port) standards
- 250 m long-distance PoE transmission (10 Mbps)
- PoE Watchdog
- Supports STP, RSTP, and MSTP
- IEEE802.1Q-based VLAN configuration
- Manual link aggregation and static LACP
- Wide voltage design (9 V–57 V)
- Desktop mount and DIN-rail mount

Access switches



PFS3005-5ET-L

5-Port Desktop Fast Ethernet Switch

- Compact design: Miniature size and light weight make it easy to deploy
- Plug and play: No configuration required
- Green technology: Adopts high quality environmentally friendly plastics
- 7×24H: Stable performance for long-term operation

Our code:
12118



PFS3008-8ET-L

8-Port Desktop Fast Ethernet Switch

- Compact design: Miniature size and light weight make it easy to deploy
- Plug and play: No configuration required
- Green technology: Adopts high quality environmentally friendly plastics
- 7×24H: Stable performance for long-term operation

Our code:
12119



PFS3005-5GT-L

5-Port Desktop Gigabit Ethernet Switch

- Compact design: Miniature size and light weight make it easy to deploy
- Plug and play: No configuration required
- Green technology: Adopts high quality environmentally friendly plastics
- 7×24H: Stable performance for long-term operation

Our code:
12120



PFS3008-8GT-L

8-Port Desktop Gigabit Ethernet Switch

- Compact design: Miniature size and light weight make it easy to deploy
- Plug and play: No configuration required
- Green technology: Adopts high quality environmentally friendly plastics
- 7×24H: Stable performance for long-term operation

Our code:
12121

Access switches



PFS3016-16GT 16-Port Gigabit Switch

- Layer 2 unmanaged access switch
- All gigabit Ethernet ports
- Lightning protection
- Plug and play
- Adopts metal enclosure
- Good heat dissipation

Our code:

12124



PFS3024-24GT 24-Port Gigabit Switch

- Layer 2 unmanaged access switch
- All gigabit Ethernet ports
- Lightning protection
- Plug and play
- Adopts metal enclosure
- Good heat dissipation

Our code:

12125



LR1002-1ET

LR1002-1EC

LR1002-1ET/LR1002-1EC Single-Port Long Reach Ethernet over Coax Extender

- Supports IEEE802.3, IEEE802.3u standards
- Supports IEEE802.3af and IEEE802.3at power supply standards
- Port: 1*RJ45 10/100Mbps, 1*BNC
- Supports RG59 coaxial cable: 400m/100Mbps, 1000m/10Mbps
- Supports MDI/MDIX self-adaption
- Supports long range power supply transmission via coaxial cable

Our code:

12089 or 12090



PFT1200 Hi-PoE Midspan

- Support PoE for Hi-PoE 60W high power consumption speed dome
- Indicator status: power (normal power on), PoE (normal power supply)
- Cooperate with PoE Extender (PFT1300), able to cascade level 2 PoE Extender, connect to 3 IPC (power consumption <=8W), max transmission distance 300m
- Installation mode: wall mount

Our code:

13164



PFT1300 PoE Extender

- Support passive PoE cascade power supply and Ethernet data exchange
- Support IEEE 802.3af/at standard power supply IP Camera
- Cooperate with High PoE Midspan (PFT1200), able to cascade level 2 PoE Extender, connect to 3 IPC (total power consumption <=25W), max transmission distance 300m
- 1*RJ45 10/100M PoE power supply input; 1*RJ45 10/100M supply power for IP Cam; 1*RJ45 10/100M supply power for the next extender
- Installation mode: junction box internal mounting, DIN rail mounting

Our code:

13165



Access Control

NEW
ARRIVAL

RF/MOBILE READERS | BIOMETRIC READERS |
CONTROLLERS | PERIPHERALS | KITS | PLATFORM

Suprema
SECURITY & BIOMETRICS

Proven Leader in Access Control, Time & Attendance And Biometric Solutions

Access control is a solution which is absolutely required in all fields and scales as a basic element of security. Suprema's access control solution is a biometrics-based system, providing greatly improved security than the access control solutions that use RF card only. Although Suprema are world leaders when it comes to biometric readers they also have in their range traditional RF readers. It is the most ideal solution equipped with all features that a user needs such as easy user management, a various zone management, elevator management or real-time monitoring. Suprema is very versatile as they have built integrations with many of the other leading Access Control manufacturers, making it easy to add Suprema devices to other manufacturers systems such as ACT, Paxton, Siemens, HID Global etc.



Milestones



Year Established

2000



Security Manufacturer

Top 50



EMEA Market Share

No.1

in Biometric Access Control
(IHS Markit)



Number of people using
Suprema technologies

1 Billion +



Systems
in Operation

1.5 Million +



Industry Patents and
Intellectual Properties

100+

Why Suprema?

- The world's best performing biometrics: Facial recognition & fingerprint recognition.
- The world's most widespread biometric technology.
- Technology partnership with over 100 global vendors in security industry.
- Strong commitment to innovation.
- Excellence in quality: Quality management system and process for quality assurance.
- Access to free online courses and video tutorials.

X-Station 2

X-Station 2 is a **versatile intelligent terminal** that supports RFID cards, Mobile Access as well as QR codes, offering the ultimate flexibility in terms of credential options and system design.

Features



Multi-technology Terminal with Various Credential Options



Comprehensive RFID Card Compatibility



Enhanced Security and Data Protection



Designed for easy deployment and management



Improved Usability of Android UI on Touchscreen



Expanded Capacity for more users and security logs



XS2-DPB

X-Station 2 RF Card Reader, Dual RFID

- RFID RF Option: 125 kHz EM & 13.56 MHz MIFARE, MIFARE Plus, DESFire EV1/EV21, FeliCa
- Mobile Card NFC, BLE
- CPU 1.5 GHz Quad Core
- Max. User 500,000
- IP65
- Dimensions (WxHxD, mm) 82 mm x 159 mm x 25.9 mm

Our code:

33052



XS2-APB

X-Station 2 RF Card Reader MultiClass

- 125 kHz EM, HID Prox & 13.56 MHz MIFARE, MIFARE Plus, DESFire EV1/EV21, FeliCa, iCLASS SE/SR/Seos
- Mobile Card NFC, BLE
- CPU 1.5 GHz Quad Core
- Max. User 500,000
- IP65
- Dimensions (WxHxD, mm) 82 mm x 159 mm x 25.9 mm

Our code:

33053



XS2-QDPB

X-Station 2 RF Card Reader, Dual RFID, QR/Barcode

- RFID RF Option: 125 kHz EM & 13.56 MHz MIFARE, MIFARE Plus, DESFire EV1/EV21, FeliCa
- Mobile Card NFC, BLE
- QR/Barcode supported
- CPU 1.5 GHz Quad Core
- Max. User 500,000
- IP65
- Dimensions (WxHxD, mm) 82 mm x 159 mm x 33.9 mm

Our code:

33054



XS2-QAPB

X-Station 2 RF Card Reader MultiClass, QR/Barcode

- 125 kHz EM, HID Prox & 13.56 MHz MIFARE, MIFARE Plus, DESFire EV1/EV21, FeliCa, iCLASS SE/SR/Seos
- Mobile Card NFC, BLE
- QR/Barcode supported
- CPU 1.5 GHz Quad Core
- Max. User 500,000
- IP65
- Dimensions (WxHxD, mm) 82 mm x 159 mm x 33.9 mm

Our code:

33055

XPass 2

XPass 2 is an **outdoor compact RFID reader** based on Suprema's state-of-the-art RFID technology and multi-hardware platform.

Features



Mobile card (NFC and BLE)



IP67 - Water and Dust Resistant



Industry standard communication via Open Supervised Device Protocol (OSDP)
OSDP verified by SIA (Security Industry Association)



IK08 - Vandal Resistant



Multi-type hardware structure



Multi-card Reading



Enhanced security with the Secure Element



Issue the smart card by using BioStar 2



XP2-GKDPB

XPass 2 Outdoor Networked compact Keypad RFID Reader

- 125 kHz card compatibility: EM
- 13.56 MHz card compatibility: MIFARE, MIFARE Plus, DESFire EV1/EV2*, FeliCa
- Mobile card: NFC, BLE
- CPU: 1 GHz
- Dimensions (WxHxD, mm): 80 x 130 x 25

Our code:

33058



XP2-GDPB

XPass 2 Outdoor Networked compact RFID Reader

- 125 kHz card compatibility: EM
- 13.56 MHz card compatibility: MIFARE, MIFARE Plus, DESFire EV1/EV2*, FeliCa
- Mobile card: NFC, BLE
- CPU: 1 GHz
- Dimensions (WxHxD, mm): 80 x 130 x 25

Our code:

33057



XP2-MDPB

XPass 2 Outdoor compact Mullion RFID Reader

- 125 kHz card compatibility: EM
- 13.56 MHz card compatibility: MIFARE, MIFARE Plus, DESFire EV1/EV2*, FeliCa
- Mobile card: NFC, BLE
- CPU: 1 GHz
- Dimensions (WxHxD, mm): 48 x 144.7 x 27

Our code:

33056

XPass D2

XPass D2 is an **outdoor compact RFID reader** based on Suprema's state-of-the-art RFID technology and multi-hardware platform, optimized for centralized access control systems such as Suprema's CoreStation.

Features



Mobile card (NFC and BLE)



IP67 - Water and Dust Resistant



Industry standard communication via Open Supervised Device Protocol (OSDP)
OSDP verified by SIA (Security Industry Association)



IK08 - Vandal Resistant



Multi-type hardware structure



Multi-card Reading



Enhanced security with the Secure Element



Issue the smart card by using BioStar 2



XP2D-GKDB

XPass D2 Outdoor compact Keypad RFID Reader

- 125 kHz card compatibility: EM
- 13.56 MHz card compatibility: MIFARE, MIFARE Plus, DESFire EV1/EV2*, FeliCa
- Mobile card: NFC, BLE
- CPU: 80 MHz
- Dimensions (WxHxD, mm): 80 x 130 x 25

Our code:

33024



XP2D-GDB

XPass D2 Outdoor compact RFID Reader

- 125 kHz card compatibility: EM
- 13.56 MHz card compatibility: MIFARE, MIFARE Plus, DESFire EV1/EV2*, FeliCa
- Mobile card: NFC, BLE
- CPU: 80 MHz
- Dimensions (WxHxD, mm): 80 x 130 x 25

Our code:

33023



XP2D-MDB

XPass D2 Outdoor compact Mullion RFID Reader

- 125 kHz card compatibility: EM
- 13.56 MHz card compatibility: MIFARE, MIFARE Plus, DESFire EV1/EV2*, FeliCa
- Mobile card: NFC, BLE
- CPU: 80 MHz
- Dimensions (WxHxD, mm): 48 x 144.7 x 27

Our code:

33022

XPass S2

XPass S2 is a **multi-smartcard device** containing advanced features of a high-end IP access control device making it versatile and powerful.



XPS2M-V2

Intelligent IP Multi-smartcard Access Control Device

- Smartcard reader
- 13.56MHz, Mifare/DesFire
- Ultra-slim design
- Max. 50,000 users
- PoE
- Wide operating temperature range: -35°C to 65°C
- IP65 housing

Our code:**33059**

Airfob Patch

Suprema Airfob Patch is a device that attaches itself easily to existing RF card readers to make them compatible with credentials stored in mobile device. It translates BLE signals into RF signals and enables communication between mobile device and RF card readers.



AP-M

Mobile-To-RF-card converter

- Energy Supply: Energy harvesting from card reader
- Dimensions (W x H x D): 32 mm x 33.5 mm x 5.7 mm
- Wireless Communication Compatibility: BLE (Bluetooth Low Energy) 4.0
- Card Compatibility: 13.56MHz MIFARE CSN / NFC Smart card*
- LED: Power status & card emulation
- IP Rating: IP 65

Our code:**33012**

FaceStation F2

Suprema **FaceStation F2** is a fusion multimodal terminal with unmatched face recognition performance. Experience the exceptional authentication accuracy and anti-spoofing performance achieved by Suprema's unique Fusion technology.

Features



Face recognition performance by Fusion Matching



Contactless solution for new standards of safety and hygiene



Best-in-class multimodal: Face, Fingerprint, Mobile and Card access



Robust device security and data encryption



FSF2-DB

FaceStation F2 Dual RFID, Fusion Face Recognition

- Biometric : Face
- RF Option : 125kHz EM & 13.56MHz MIFARE, MIFARE Plus, DESFire EV1/EV21), FeliCa
- RF read range EM/MIFARE/DESFire : 50 mm, FeliCa: 30 mm
- Mobile: NFC, BLE
- CPU: 1.8 GHz Dual Core + 1.4 GHz Quad Core
- Face: Matching speed: Less than 0.5 sec
- Anti-Spoofing: Supported
- RS-485: 1ch Host or Slave (Selectable)
- Wiegand: 1ch Input or Output (Selectable)
- Max. Text Log: 5,000,000
- Max. Image Log: 50,000

Our code:

33013



FSF2-AB

FaceStation F2 MultiCLASS SE, Dual RFID, Fusion Face Recognition

- Biometric : Face
- RF Option : 125kHz EM, HID Prox & 13.56MHz MIFARE, MIFARE Plus, DESFire EV1/EV21), FeliCa, iCLASS SE/SR/Seos
- RF read range EM/MIFARE/DESFire : 50 mm, FeliCa: 30 mm
- Mobile: NFC, BLE
- CPU: 1.8 GHz Dual Core + 1.4 GHz Quad Core
- Face: Matching speed: Less than 0.5 sec
- Anti-Spoofing: Supported
- RS-485: 1ch Host or Slave (Selectable)
- Wiegand: 1ch Input or Output (Selectable)
- Max. Text Log: 5,000,000
- Max. Image Log: 50,000

Our code:

33014



FSF2-ODB

FaceStation F2 Dual RFID, Fusion Face + Fingerprint Recognition

- Biometric : Face, Fingerprint
- RF Option : 125kHz EM & 13.56MHz MIFARE, MIFARE Plus, DESFire EV1/EV21), FeliCa
- RF read range EM/MIFARE/DESFire : 50 mm, FeliCa: 30 mm
- Mobile: NFC, BLE
- CPU: 1.8 GHz Dual Core + 1.4 GHz Quad Core
- Face: Matching speed: Less than 0.5 sec
- Anti-Spoofing: Supported
- RS-485: 1ch Host or Slave (Selectable)
- Wiegand: 1ch Input or Output (Selectable)
- Max. Text Log: 5,000,000
- Max. Image Log: 50,000

Our code:

33015

X-Station 2

Suprema **FaceStation 2** is the most advanced face recognition terminal providing loads of the world's best features. Powered by Suprema's latest innovation in facial biometrics, FaceStation 2 offers unrivalled matching speed, accuracy and level of security.

Features



Ultra Performance



Multi RFID Card Reading



Enhanced Security



25,000 lx

Highest Operating Illuminance



Ergonomics & User Convenience



FS2-D

**FaceStation 2 Smart Face recognition terminal,
Dual RFID**

- Biometric : Face
- RF Options: 125kHz EM & 13.56MHz MIFARE, MIFARE Plus, DESFire EV1/EV2*, FeliCa, NFC
- RF Read Range: MIFARE/DESFire/iCLASS : 50 mm EM/HID
- Prox/FeliCa: 30 mm, BLE: 50 mm
- CPU: 1.4 GHz Quad Core
- Live Face Detection Supported
- Max. User: 30,000 (1:1), 4,000(1:N)
- Max. Log: 5,000,000 (text), 50,000 (image)
- Tamper Supported
- Video Phone SIP-based VoIP (Video + Voice)
- RS-485: 1ch Host or Slave (Selectable)
- Wiegand: 1ch In and 1ch Out

Our code:

33016



FS2-AWB

**FaceStation F2 MultiCLASS SE,
Smart Face recognition terminal, Dual RFID**

- Biometric : Face
- RF Options: 125kHz EM, HID Prox & 13.56MHz MIFARE, MIFARE Plus, DESFire EV1/EV2*, FeliCa, iCLASS SE/SR/Seos, NFC & 2.4GHz BLE
- RF Read Range: MIFARE/DESFire/iCLASS : 50 mm EM/HID Prox/FeliCa: 30 mm, BLE: 50 mm
- CPU: 1.4 GHz Quad Core
- Live Face Detection Supported
- Max. User: 30,000 (1:1), 4,000(1:N)
- Max. Log: 5,000,000 (text), 50,000 (image)
- Tamper Supported
- Video Phone SIP-based VoIP (Video + Voice)
- RS-485: 1ch Host or Slave (Selectable)
- Wiegand: 1ch In and 1ch Out

Our code:

33017

FaceLite

Suprema FaceLite is **the most compact face recognition terminal** providing loads of the world's best features. Powered by Suprema's latest innovation in facial biometrics, FaceLite offers unrivaled matching speed, accuracy, and level of security.

Features



Ultra Performance



Multi RFID Card Reading



Enhanced Security



25,000 lx

Highest Operating Illuminance



Ergonomics & User Convenience



FL-DB

FaceLite Compact Facial recognition Terminal, Dual RFID

- Biometric : Face
- RF Options: 125kHz EM & 13.56MHz MIFARE, MIFARE Plus, DESFire EV1/EV2*, FeliCa
- Mobile Card: NFC, BLE
- CPU: 1.2GHz Quad Core
- Max. User: 30,000(1:1), 4,000(1:N)
- Max. Log: 5,000,000
- Tamper Supported
- Ethernet: 10/100Mbps, auto MDI/MDI-X
- RS-485: 1ch Host or Slave (Selectable)
- Wiegand: 1ch Input or Output (Selectable)
- TTL: 2ch Inputs
- Relay: 1 Relay

Our code:

33018

BioEntry R2

Suprema BioEntry R2 is a **Compact RFID card & Fingerprint Reader** exclusively designed for centralized access control systems. Packed in a slim, mullion-type design, BioEntry R2 provides high-definition fingerprint image capture, minutiae extraction as well as dual-frequency multi RF card reading capability. Combined with Suprema's intelligent biometric controller, the CoreStation, BioEntry R2 completes biometrics-driven access control system with enhanced simplicity and level of security of centralized system topology.



BER2-OD

BioEntry R2 Compact fingerprint slave reader, Dual RFID, Optical Sensor

- Sensor Type Optical Sensor (OP6)
- RF Option 125kHz EM & 13.56MHz MIFARE, MIFARE Plus, DESFire EV1/EV2*, FeliCa, NFC
- CPU 1.0 GHz
- Sound Multi-tone Buzzer
- RS-485 1ch Slave, OSDP V2.1.6
- Tamper Supported
- Dimensions (WxHxD, mm) 50 x 164 x 37.5
- Latest Suprema fingerprint algorithm
- High-precision OP5 optical sensor
- Open Supervised Device Protocol (OSDP)

Our code:

33025

BioEntry P2

Suprema BioEntry P2 is a compact fingerprint access control device featuring Suprema's next generation biometric technology and security platform.

Features



Best-in-class Performance



Multi RFID Card Reading



Enterprise-level Capacity



Versatile Interfaces



BEP2-OA / BEP2-OD

BioEntry P2 - Compact IP Fingerprint Device

- RF Option:
 - **BEP2-OA:** 125kHz EM, HID Prox & 13.56MHz MIFARE, MIFARE Plus, DESFire EV1/EV2*, FeliCa, iCLASS SE/SR/Seos, NFC
 - **BEP2-OD:** 125kHz EM & 13.56MHz MIFARE, MIFARE Plus,
- DESFire/EV1, FeliCa, NFC
- Fast matching: Max 10,000 match/sec
- Powerful 1.0GHz CPU
- High-precision OP6 optical sensor
- Max. 10,000 users
- Max. 1,000,000 event logs
- Communication: TCP/IP, RS-485, Wiegand
- Input/output: TTL I/O, Relay

Our code:

| | |
|----------------|----------------|
| BEP2-OA | BEP2-OD |
| 33051 | 33050 |

BioEntry W2

Suprema BioEntry W2 is a rugged fingerprint access control device featuring Suprema's next generation biometric technology and security platform. BioEntry W2 provides class-leading performance and security by featuring Suprema's latest fingerprint algorithm coupled by powerful quad-core CPU and LFD(live finger detection) technology.

Features



Best-in-class Performance



Multi RFID Card Reading



Rugged Structure



Improved Accuracy & Security



Expanded Capacity



BEW2-OHPB / BEW2-ODPB / BEW2-OAPB

BioEntry W2 - Outdoor fingerprint recognition

- RF Option:
 - **BEW2-OHPB:** 125kHz EM, HID Prox & 13.56MHz MIFARE, MIFARE Plus, DESFire EV1/EV2, FeliCa, NFC, 2.4GHz BLE
 - **BEW2-ODPB:** 125kHz EM & 13.56MHz MIFARE, MIFARE Plus, DESFire EV1/EV2, FeliCa, NFC, 2.4GHz BLE
 - **BEW2-OAPB:** 125kHz EM, HID Prox & 13.56MHz MIFARE, MIFARE Plus, DESFire EV1/EV2*, FeliCa, iCLASS SE/SR/Seos, NFC, 2.4GHz BLE
- New advanced Live Finger Detection (LFD) technique
- High-precision OP5 optical sensor
- Max. 500k users/1 million text logs
- Large memory: 2GB Flash + 256 MB RAM

Our code:

| | |
|------------------|------------------|
| BEW2-OHPB | BEW2-ODPB |
| 33048 | 33047 |
| BEW2-OAPB | |
| 33049 | |

BioLite N2

Suprema BioLite N2 is a Suprema's **2nd generation outdoor fingerprint terminal** that provides comprehensive access control and time attendance features based on Suprema's latest biometric technology and security platform.

Features

- Best-in-class Performance
- Multi RFID Card Reading

- Advanced Accuracy & Security
- Full Time Attendance Features



BLN2-ODB / BLN2-OAB BioLite N2 Outdoor IP Fingerprint Terminal

- RF Option:
 - **BLN2-ODB**: 125kHz EM & 13.56MHz MIFARE, MIFARE Plus, DESFire EV1/EV2, FeliCa, NFC & 2.4GHz BLE
 - **BLN2-OAB**: 125kHz EM, HID Prox & 13.56MHz MIFARE, MIFARE Plus, DESFire EV1/EV2, FeliCa, iCLASS SE/SR/Seos
- 1.2 GHz CPU
- Dual-frequency RFID card technology
- Capable of matching up to 20,000 fingerprints in a second
- AES encrypted NFC host card emulation for Android
- AES 128-bit encrypted BLE communication for iOS and Android
- Holds up to 1,000,000 text logs
- Numeric keypad, escape button, function buttons, and OK button
- Tamper-resistant housing, IP67

Our code:

BLN2-ODB
33044

BLN2-OAB
33045

BLN2-PAB BioLite N2 Outdoor IP Fingerprint Terminal FBI PIV Certification

- RF Option: 125kHz EM, HID Prox & 13.56MHz MIFARE, MIFARE Plus, DESFire EV1/EV2, FeliCa, iCLASS SE/SR/Seos
- FBI PIV Certification (FAP 10) : OEM SFU-550 (SFU-P2) & fingerprint sensing module OPV single finger livescan capture device without membrane at 500ppi (PIV-071006 and Mobile ID FAP 10)
- 1.2 GHz CPU
- Dual-frequency RFID card technology
- Capable of matching up to 20,000 fingerprints in a second
- AES encrypted NFC host card emulation for Android
- AES 128-bit encrypted BLE communication for iOS and Android
- Holds up to 1,000,000 text logs
- Numeric keypad, escape button, function buttons, and OK button
- Tamper-resistant housing, IP67

Our code:

33046

BioStation L2

Suprema BioStation L2 is an **essential fingerprint terminal that provides comprehensive access control and time attendance** features based on Suprema's next generation biometric technology and security platform. Designed for all type of time-attendance applications, BioStation L2 provides exceptional value by combining World's best Suprema fingerprint algorithm, high performance and enhanced security features



BSL2-OE / BSL2-OM BioStation L2 - Fingerprint IP Access terminal

- RF Option:
 - **BSL2-OE**: 125kHz EM
 - **BSL2-OM**: 13.56 MHz Mifare/DESFire/DESFire EV1/FeliCa/NFC
- 1.2GHz Quad-Core CPU
- Up to 150,000 matches per second
- Max. 500k users /1 million text logs
- Large memory: 2GB Flash + 256 MB RAM
- 2-inch color LCD with intuitive GUI
- Full time and attendance functionality
- Wiegand, RS485, TTL I/O, relay

Our code:

BSL2-OE
33042

BSL2-OM
33043

BioStation A2

Suprema BioStation A2 is **the most advanced fingerprint access control and time attendance terminal** featuring Suprema's next generation biometric technology and security platform. BioStation A2 provides class-leading performance through the World's best matching performance, uncompromised security and accuracy along with top-notch usability.

Features



World's Fastest Performance



Improved Accuracy & Security



Best-in-class Features



Versatile Interfaces



Expanded Capacity



BSA2-OEPW

BioStation A2 IP Fingerprint Terminal

- RF Option: 125kHz EM
- Up to 150,000 fingerprint matches per second
- Advanced LFD (live finger detection) technology
- Max. 500,000 users
- 5" IPS LCD touchscreen with reinforced glass front
- 2MP wide-angle camera for clear face image logs
- Built-in WiFi
- PoE

Our code:

33034



BSA2-OMPW

BioStation A2 IP Fingerprint Terminal

- RF Option: 13.56MHz MIFARE, MIFARE Plus, DESFire EV1/EV2 FeliCa, NFC
- Up to 150,000 fingerprint matches per second
- Advanced LFD (live finger detection) technology
- Max. 500,000 users
- 5" IPS LCD touchscreen with reinforced glass front
- 2MP wide-angle camera for clear face image logs
- Built-in WiFi
- PoE

Our code:

33035



BSA2-OHPW

BioStation A2 IP Fingerprint Terminal

- RF Option: 125kHz HID Prox
- Up to 150,000 fingerprint matches per second
- Advanced LFD (live finger detection) technology
- Max. 500,000 users
- 5" IPS LCD touchscreen with reinforced glass front
- 2MP wide-angle camera for clear face image logs
- Built-in WiFi
- PoE

Our code:

33036



BSA2-OIPW

BioStation A2 IP Fingerprint Terminal

- RF Option: 13.56MHz iCLASS SE/SR/Seos, NFC
- Up to 150,000 fingerprint matches per second
- Advanced LFD (live finger detection) technology
- Max. 500,000 users
- 5" IPS LCD touchscreen with reinforced glass front
- 2MP wide-angle camera for clear face image logs
- Built-in WiFi
- PoE

Our code:

33037

BioStation 2

BioStation 2 incorporates the latest Suprema technology in a beautiful exterior. It combines a new powerful processor, Suprema's next generation optical sensor and improved fingerprint sensing & capturing algorithm to offer unrivaled performance.

Features



Instant Matching & Authentication



Rapid Data Transfer



IP65 certified Dust & Water protection



Versatile Interface



Expanded Memory Capacity



BS2-OEPW

BioStation 2 IP Fingerprint Terminal

- RF Option: 125kHz EM
- Instant fingerprint matching & authentication (up to 20,000 fingerprints per second)
- Max. 500,000 users
- Built-in WiFi
- PoE
- IP65 housing
- Built-in WiFi and Power-over-Ethernet functionality

Our code:

33038



BS2-OMPW

BioStation 2 IP Fingerprint Terminal

- RF Option: 13.56Mhz MIFARE, MIFARE Plus, DESFire/EV1, FeliCa, NFC
- Instant fingerprint matching & authentication (up to 20,000 fingerprints per second)
- Max. 500,000 users
- Built-in WiFi
- PoE
- IP65 housing
- Built-in WiFi and Power-over-Ethernet functionality

Our code:

33039



BS2-OHPW

BioStation 2 IP Fingerprint Terminal

- RF Option: 125kHz HID Prox
- Instant fingerprint matching & authentication (up to 20,000 fingerprints per second)
- Max. 500,000 users
- Built-in WiFi
- PoE
- IP65 housing
- Built-in WiFi and Power-over-Ethernet functionality

Our code:

33040



BS2-OIPW

BioStation 2 IP Fingerprint Terminal

- RF Option: 13.56MHz MIFARE, DESFire/EV1, FeliCa, iCLASS SE/SR, NFC, ISO14443A
- Instant fingerprint matching & authentication (up to 20,000 fingerprints per second)
- Max. 500,000 users
- Built-in WiFi
- PoE
- IP65 housing
- Built-in WiFi and Power-over-Ethernet functionality

Our code:

33041

CoreStation

Suprema CoreStation is an **intelligent door controller** which provides the advantages of a biometric-enabled security over a centralized access control system. Designed to accommodate enterprise-level systems, the CoreStation can store up to 500,000 users with an incredible fingerprint matching speed of up to 400,000 match/sec. With its high-performance, biometric readiness, Ethernet communication, CoreStation is also capable of offering the full features of the BioStar2 platform.

Features

-  Centralized Biometric Access Control
-  System Flexibility and Scalability
-  Enterprise-level Capacity
-  Fully Compatible with BioStar 2
-  Improved Security



CS-40 CoreStation Intelligent biometric controller

- CPU: 1.4 GHz Octa Core
- Memory: 8 GB Flash + 1 GB RAM
- Max. User (1:1)*: 500 000
- Max. User (1:N)*: 100 000
- Max. Face User (1:1)*: 30 000
- Max. Face User (1:N)*: 4000
- Max. Logs: 5 000 000 (text)
- Ethernet: 10/100Mbps, auto MDI/MDI-X
- RS-485: 5 ch
- Wiegand: 4 ch input
- Relay: 4 relays
- TTL Input: 8 ch (Supervised input selectable), TTL Output: 8 ch
- AUX Input: 2 ch (AC Power Fail, Tamper)

Our code:

33020

System Configurations

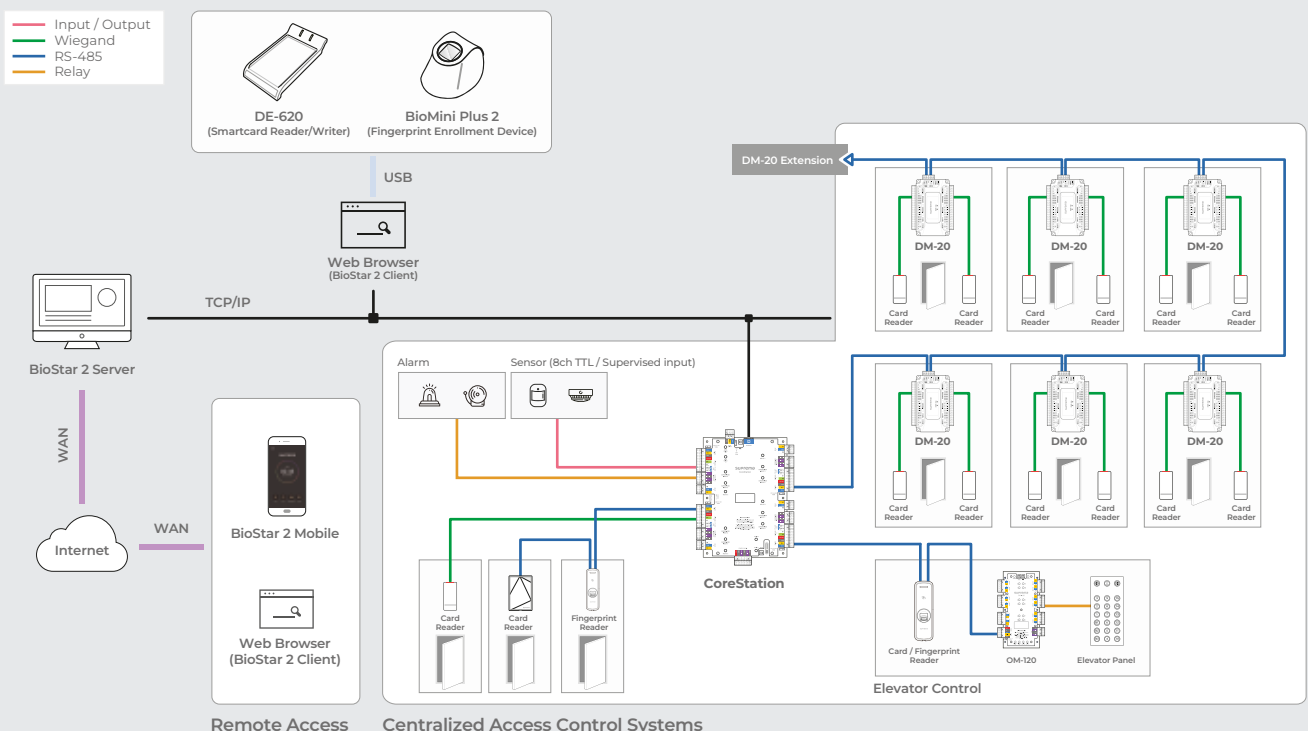



TCM10-FS2

Suprema Thermal Camera module (only)

- Compatible Face Recognition Terminal : FaceStation 2
- NETD (Noise Equivalent Temperature Difference): ≤ 50 mK (@25 °C, F# = 1.0)
- Field of View: 37.2° x 50° (H * V)
- Temperature Range: 30°C to 45°C
- Temperature Accuracy*: $\leq \pm 0.5^\circ\text{C}$ (0.9°F)*/ $\pm 0.3^\circ\text{C}$ (0.5°F)**
- Temperature Distance: 40 cm-80 cm
- Operating Temperature: 0°C to 50°C

Our code:

33019



SIO2

Compact secure single door I/O module

- CPU: Cortex M3 72MHz
- Memory 128KB Flash + 20 KB RAM
- Certificates: CE, FCC, KC, RoHS
- RS 485: 1 ch
- TTL input: 2 ch
- 1 Relay
- Enhanced security due to encrypted communication
- Easy installation and low cost

Our code:

33033



OM-120

Output Control Module (12 outputs)

- CPU: Cortex M3 72MHz
- Memory 128KB Flash + 20KB SRAM
- Certificates: CE, FCC, KC, RoHS, REACH, WEEE
- RS 485: 1 ch
- 12 Relays
- AUX input: 2ch dry contact input
- 31 units can be connected to a master device via RS485 daisy chain
- Anti-passback feature and a fire alarm feature.

Our code:

33030



DM-20

Multi Door Interface Module (8 inputs / 6 outputs)

- CPU: Cortex M3 72MHz
- Memory 128KB Flash + 20 KB SRAM
- RS 485: 1 ch
- TTL input: 4 ch
- Wiegand: 2 ch
- 4 Relays
- Supervised Input: 4 ch
- TTL Output: 6 ch
- Secure door control of up to four doors

Our code:

33031



CST-4DR-D2M
CoreStation Biometric Access Controller 4-Door Kit

This kit includes one Suprema's CoreStation Biometric Access Controller and four XPD2-MBD XPass D2 compact RFID readers.

Our code:
33026



CST-4DR-D2G
CoreStation Biometric Access Controller 4-Door Kit

This kit includes one Suprema's CoreStation Biometric Access Controller and four XPD2-GDB XPass D2 Outdoor Compact RFID Readers.

Our code:
33027



CST-4DR-D2GK
CoreStation Biometric Access Controller 4-Door Kit

This kit includes one Suprema's CoreStation Biometric Access Controller and four XPD2-GKDB XPass D2 compact RFID readers.

Our code:
33028



CST-4DR-R2
CoreStation Biometric Access Controller 4-Door Kit

This kit includes one Suprema's CoreStation Biometric Access Controller and four BER2-OD BioEntry R2 Compact fingerprint readers.

Our code:
33029

BioStar 2

BioStar 2 is a **web-based, open, and integrated security platform** that provides comprehensive functionality for access control, time & attendance management, visitor management, and video log maintenance. It encrypts all personal data available and supports both SDKs and web APIs to integrate BioStar 2 with third-party software. In addition, users can control BioStar 2 platform remotely with the mobile app for BioStar 2 and manage a mobile access card that you can use to access sites.

Features



Biometrics-Based



Low Maintenance Cost



Mobile App Support



Remote Control Support



System Integration Tool Support

Access Control License

| | | Basic | Standard | Advanced | Professional | Enterprise |
|-----------------------------|---|--------------|-------------|--------------|--------------|--------------|
| Item | Pt number | BioStar2-BAS | BioStar2-ST | BioStar2-ADV | BioStar2-PRO | BioStar2-ENT |
| | Our code | 33000 | 33001 | 33002 | 33003 | 33004 |
| Access Control | No. of Doors | 20 | 50 | 100 | 300 | 1000 |
| | Maximum No. of Connected Devices | 1000 | 1000 | 1000 | 1000 | 1000 |
| | Maximum No. of Access Levels 1) | 2048 | 2048 | 2048 | 2048 | 2048 |
| | Maximum No. of Access Groups 1) | 2048 | 2048 | 2048 | 2048 | 2048 |
| | Maximum No. of Access Groups per User | 16 | 16 | 16 | 16 | 16 |
| | Maximum No. of Access Levels per Access | 128 | 128 | 128 | 128 | 128 |
| | Access Group Auto Sync | • | • | • | • | • |
| Users | Maximum No. of Cards per User | 8 | 8 | 8 | 8 | 8 |
| | Maximum No. of Fingerprints per User | 10 | 10 | 10 | 10 | 10 |
| | User Auto Sync | • | • | • | • | • |
| | Access-on-Card | • | • | • | • | • |
| | Security Credential Cards | • | • | • | • | • |
| | iCLASS Seos Card | • | • | • | • | • |
| | Long-term Idle Users Management | • | • | • | • | • |
| | Custom Field | • | • | • | • | • |
| Elevator Control | Elevators | - | - | • | • | • |
| | Maximum No. of Floors per Elevator | - | - | 192 | 192 | 192 |
| | Maximum No. of Floor Levels | - | - | 2,048 | 2,048 | 2,048 |
| Zones | Anti-Passback | ▲(Door) | • | • | • | • |
| | Fire Alarm | - | • | • | • | • |
| | Schedule Lock/Unlock | - | • | • | • | • |
| | Intrusion Alarm Zone | - | • | • | • | • |
| | Interlock Zone | - | • | • | • | • |
| | Muster Zone | - | • | • | • | • |
| | Elevators | - | - | • | • | • |
| | Maximum No. of Floors per Elevator | - | - | 192 | 192 | 192 |
| Maximum No. of Floor Levels | - | - | 2048 | 2048 | | |
| Advanced Features | Dashboard | • | • | • | • | • |
| | Cloud | - | • | • | • | • |
| | New Local API | • | • | • | • | • |
| | Server Matching | - | - | • | • | • |
| | Audit Trail | • | • | • | • | • |
| | Daylight Saving Time | • | • | • | • | • |
| | Dual Authentication | • | • | • | • | • |
| Active Directory | - | - | • | • | • | |
| Monitoring | Graphic Map | - | - | • | • | • |

BioStar 2 TA

BioStar 2 TA is a **time and attendance module** that serves as an add-on for the BioStar 2 platform. The BioStar 2 TA module provides comprehensive time and attendance functionalities to BioStar 2. Combined with features such as multiple shift types and overtime rule, BioStar 2 TA simplifies complicated time and attendance management by offering flexibility for diverse applications.

Features



Biometrics-Based



Low Maintenance Cost



Mobile App Support



Remote Control Support



System Integration Tool Support

Time Attendance License

| | | Standard | Advanced | Professional |
|------|--------------|-----------------|-----------------|-----------------|
| Item | Pt number | BioStar2-TA-STD | BioStar2-TA-ADV | BioStar2-TA-PRO |
| | Our code | 33005 | 33006 | 33007 |
| | No. of Users | 500 | 1000 | UNLIMITED |

Visitor Management License

| | | |
|------|----------|------------------|
| Item | Pt numbe | BioStar2-VISITOR |
| | Our code | 33008 |
| | | |

Mobile Access

Suprema Mobile Access allows you to use your own smartphone as a key to access doors, facilities, and more. By using your smartphone as a credential, managing and using an access card becomes easier, faster, and safer. Just Tap & Go.



| | | | |
|------|-----------|----------------------|---------------------------------------|
| Item | Pt number | MOBILE-ACCESS-CREDIT | MOBILE-ACCESS-MAINT-CREDIT (recharge) |
| | Our code | 33010 | 33011 |
| | | | |



ASI6213J-MW

FACT Access Control Terminal

- 4.3-inch LCD touch screen; resolution 480 × 272
- 2MP wide-angle dual lens camera; support DWDR, white light fill light and IR fill light
- Support face, card, password unlock and unlock through their combinations; support unlock by period
- User data can be stored at the access controller; can hold 6000 face images and work without network
- Face-camera distance: 0.3 m-1.5 m
- Face verification accuracy 99.5%; face comparison speed 0.3s per person; low false recognition rate; support liveness detection

Our code:

13201



ASI3213G-MW

FACT Access Control Terminal

- 4.3 inch LCD touch screen; resolution 480×272
- With 2 MP wide-angle dual lens, white fill light, IR light
- Support face, card and password unlock; unlock by period
- User data can be stored at the access controller; can hold 1500 face images and work without network
- Face-camera distance: 0.3m-1.5m
- Face verification accuracy 99.5%; face comparison speed 0.3s per person; low false recognition rate
- Support liveness detection

Our code:

13181



ASI7213X-T1

Thermal Face Recognition Reader TMAC

- 2.5D curved screen
- 7-inch LCD display with resolution of 1024 × 600
- 2MP CMOS, WDR
- Auto illumination reduces light pollution
- Can hold 100,000 users, 100,000 face images, 100,000 cards, 100,000 password, 50 administrators, and 300,000 records
- Support face, IC card, password unlock and unlock through their combinations
- With face detection box; the largest face among faces that appear at the same time is recognized first; the maximum face size can be configured on the web
- Face-camera distance: 0.3 m–2.0 m; human height: 0.9 m–2.4 m (lens-ground distance: 1.4 m)
- With face recognition algorithm, the terminal can recognize more than 360 positions on human face
- Face recognition speed: 0.2 s per face
- Support liveness detection
- Accurate recognition in backlight and front light
- Various unlock status display modes protect user privacy
- Support enabling/disabling the temperature monitoring mode; temperature monitoring range is 30°C to 45°C; temperature monitoring distance range is 0.3 m–1.8 m; temperature monitoring error is $\leq 0.5^\circ\text{C}$; report temperature anomaly alarm
- Support mask detection, report alarm of abnormal events without wearing a mask
- Support duress alarm, tamper alarm, intrusion alarm, door contact timeout alarm, and illegal card exceeding threshold alarm
- Support general users, patrol users, VIP users, guest users, and special users

Our code:

13176



Our code:
13163

ASI7214Y

Face Recognition Access Control and Time Attendance Terminal

- 7 inch LCD, touchscreen, resolution 1024 (H) × 600 (V).
- Human face images, fingerprints, cards and passwords can be recorded
- Support unlock through face, card, password, and their combinations; and support unlock in certain periods.
- With face detection box; the largest face among faces that appear at the same time is recognized first; the maximum face size can be configured on the web.
- Face recognition distance is 0.3 m–2 m, human height range is 1.1m–2.4m
- Face verification accuracy >99%; face comparison speed ≤0.5s per person; false recognition rate <0.1%. Support liveness detection.
- Support duress alarm, tamper alarm, intrusion alarm, door contact timeout alarm, and illegal card exceeding time alarm.
- Has six user levels: general users, patrol users, blacklist users, VIP users, guests, and disabled users.
- Attendance records can be uploaded to the management platform.



Our code:
13167

ASI7214X

Face Recognition Access Control

- 2.5D curved screen
- 7 Inch LCD display with resolution of 1024×600
- 200 MP CMOS, WDR
- Vehicle level LCD whose working temperature is -30°C to 50°C
- IP65 (Silicone sealant is needed. For details, see the quick start guide.)
- Auto fill light reduces light pollution
- Can hold 100,000 users, 100,000 face images, 10,000 fingerprints,
- Support face, fingerprint, IC card, password unlock and unlock
- With face detection box; the largest face among faces that appear
- Face-camera distance: 0.3 m–2.0 m; human height: 0.9 m–2.4 m
- With face recognition algorithm, the access controller can recognize
- Support liveness detection
- Face recognition speed: 0.2 s per face
- Accurate recognition in backlight and front light
- Various unlock status display modes protect user privacy
- Support duress alarm, tamper alarm, intrusion alarm, door contact
- Support general users, patrol users, VIP users, guest users, and special



Our code:
13168

ASI7213X

Face Recognition Access Control

- 2.5D curved screen
- 7 Inch LCD display with resolution of 1024×600
- 200 MP CMOS, WDR
- Vehicle level LCD whose working temperature is -30°C to 60°C
- IP65 (Silicone sealant is needed. For details, see the quick start guide.)
- Auto fill light reduces light pollution
- Can hold 100,000 users, 100,000 face images, 100,000 cards, 100,000
- Support face, IC card, password unlock and unlock through their
- With face detection box; the largest face among faces that appear
- Face-camera distance: 0.3 m–2.0 m; human height: 0.9 m–2.4 m
- With face recognition algorithm, the access controller can recognize
- Face recognition speed: 0.2 s per face
- Support liveness detection
- Accurate recognition in backlight and front light
- Various unlock status display modes protect user privacy
- Support duress alarm, tamper alarm, intrusion alarm, door contact
- Support general users, patrol users, VIP users, guest users, and special



Our code:
13173

AS17223X-A Face Recognition Terminal

- 2.5D curved screen
- 7 Inch LCD display with resolution of 1024×600
- 2 MP CMOS, WDR
- Vehicle level LCD whose working temperature is -30°C to 60°C
- IP65 (Silicone sealant is needed. For details, see the quick start guide.)
- Auto fill light reduces light pollution
- Can hold 100,000 users, 100,000 face images, 100,000 password, 50 administrators, and 300,000 records
- Support face and password unlock and unlock through their combinations
- With face detection box; the largest face among faces that appear at the same time is recognized first; the maximum face size can be configured on the web
- Face-camera distance: 0.3 m–2.0 m; human height: 0.9 m–2.4 m (lens-ground distance: 1.4 m)
- With face recognition algorithm, the terminal can recognize more than 360 positions on human face
- Support liveness detection
- Face recognition speed: 0.2 s per face
- Accurate recognition in backlight and front light
- Various unlock status display modes protect user privacy
- Support duress alarm and tamper alarm
- Support general users, patrol users, VIP users, guest users, and special users



Our code:
13169

AS18223Y-A-V3 Face Recognition Terminal

- Aluminium alloy housing with wire-drawing treatment; IP55 (Apply silica gel to gaps between the device and the wall. Liquid sodium silicate is recommended. For details, see the quick start guide.)
- 10.1 inch LCD touch screen; resolution 1280×800
- With 2 MP wide-angle dual lens, white fill light, IR light, and WDR
- Support face and password unlock; unlock by period
- User data can be stored at the access controller; can hold 100,000 face images and work without network
- Face-camera distance: 0.3m-2.0m
- Face verification accuracy ≥99.5%; face comparison speed ≤0.2s per person; low false recognition rate
- Support liveness detection



ASI1212D
Water-proof Fingerprint Standalone

- Touch keyboard and LCD display
- Support 30,000 valid cards & 150,000 records
- Support multiple cards (default IC card)
- Support card, password, fingerprint and combination
- TCP/IP to PC, support WAN communication
- Support P2P add device
- Wiegand or RS-485 interface to reader
- Door time out alarm, intrusion alarm, duress alarm and tamper alarm
- Anti-passback, multi-card open
- Support 128 efficient time and holiday schedules
- USB import/export configuration or log file

Our code:

13127



ASI1201A
RFID Standalone

- Touch keyboard and LCD display
- Support 30,000 valid cards & 150,000 records
- Support multiple cards (default IC card)
- Support card, password and combination
- TCP/IP to PC
- Wiegand or RS-485 interface to reader
- Door time out alarm, intrusion alarm, duress alarm and tamper alarm
- Anti-passback, multi-card open
- Software attendance
- Support 128 efficient time and holiday schedules
- Watch dog function ensure device free from halting

Our code:

13131



ASI1201E
Water-proof RFID Standalone

- Support 30,000 valid cards & 150,000 records
- Support multiple cards (default IC card)
- Support card, password and combination
- TCP/IP to PC
- Wiegand or RS-485 interface to reader
- Door time out alarm, intrusion alarm, duress alarm and tamper alarm
- Anti-passback, multi-card open
- Water-proof design
- Support 128 efficient time and holiday schedules
- Watch dog function ensure device free from halting

Our code:

13125



ASR1101M
Vandal-proof RFID Reader

- Support RS485, Wiegand34 protocol (Wiegand 26 optional)
- 13.56MHz (Mifare)
- All-metal buttons with blue backlight
- Red and Green indicator LEDs
- Watch dog function ensure device free from halting
- Surface mounted installation



Our code:

13121



ASR1101A
RFID Reader

- Support RS485, Wiegand34 protocol (Wiegand 26 optional)
- 13.56MHz (Mifare)
- Red and Green LEDs
- Sensitive touch keypad with blue backlight
- Watch dog function ensure device free from halting
- Beep Buzzer and LED indicator
- Surface mounted installation



Our code:

13119



ASR1100A
RFID Standalone

- Support RS485, Wiegand34 protocol(Wiegand 26 optional)
- 13.56MHz (Mifare)
- Red and Green LEDs
- Watch dog function ensure device free from halting
- Beep Buzzer and LED indicator
- Surface mounted installation



Our code:

13113



ASR1201D
Slim Water-proof RFID Reader

- Support RS485, Wiegand34 protocol (Wiegand 26 optional)
- 13.56MHz (Mifare)
- Red and Blue LEDs
- Watch dog function ensure device free from halting
- Water-proof (Outdoor use)
- Surface/Flush mounted installation



Our code:

13117



ASR1102A(V2)
Fingerprint RFID Reader

- RS-485 protocol
- Default IC (Mifare) card
- Support card, fingerprint
- Up to 3000 fingerprints capacity
- Blue backlight
- Watch dog function ensure device free from halting
- Beep and indicator
- Surface mounted installation



Our code:

13123



ASR1100B
Water-proof RFID Reader

- Support RS485, Wiegand34 protocol (Wiegand 26 optional)
- 13.56MHz (Mifare)
- Water-proof design
- Red and Green indicator LEDs
- Watch dog function ensure device free from halting
- Surface mounted installation



Our code:

13115

Without PSU



Two Door One way Access Controller
ASC1202B-D **OUR CODE : 13101**

Four Door One way Access Controller
ASC1204B-S **OUR CODE : 13103**

Support 100,000 valid cards & 150,000 records. Support card, password, fingerprint and combination. TCP/IP interface to PC. Wiegand or RS-485 interface to readers.



Two Door Slave Access Control Module
ASC2102B-T **OUR CODE : 13109**

Four Door Slave Access Control Module
ASC2104B-T **OUR CODE : 13110**

Support 20,000 valid cards & 30,000 records. Support card, password, fingerprint and combination. Only work with ASC2204-H with CAN bus. Wiegand or RS-485 interface to readers

With PSU



Two Door Two way Access Controller
ASC1202C-D **OUR CODE : 13104**

Four Door One way Access Controller
ASC1204C-S **OUR CODE : 13105**

Four Door Two way Access Controller
ASC1204C-D **OUR CODE : 13106**

Eight Door One way Access Controller
ASC1208C-S **OUR CODE : 13107**

Support 100,000 valid cards & 150,000 records. Support card, password, fingerprint and combination. TCP/IP interface to PC. Wiegand or RS-485 interface to readers.



Four Door Master Access Controller
ASC2204C-H **OUR CODE : 13108**

Support 200,000 valid cards & 150,000 records. CAN bus can cascade 16 sub controller modules. Support card, password, fingerprint and combination. TCP/IP interface. Wiegand or RS-485 interface to readers.



Our code:
13163

AS17214Y

Face Recognition Access Control and Time Attendance Terminal

- 7 inch LCD, touchscreen, resolution 1024 (H) × 600 (V).
- Human face images, fingerprints, cards and passwords can be recorded
- Support unlock through face, card, password, and their combinations; and support unlock in certain periods.
- With face detection box; the largest face among faces that appear at the same time is recognized first; the maximum face size can be configured on the web.
- Face recognition distance is 0.3 m–2 m, human height range is 1.1m-2.4m
- Face verification accuracy >99%; face comparison speed ≤0.5s per person; false recognition rate <0.1%. Support liveness detection.
- Support duress alarm, tamper alarm, intrusion alarm, door contact timeout alarm, and illegal card exceeding time alarm.
- Has six user levels: general users, patrol users, blacklist users, VIP users, guests, and disabled users.
- Attendance records can be uploaded to the management platform.



Our code:
13138

ASA1222E

Time Attendance Terminal

- 2.4 inches TFT colorful screen
- Multiple verification methods (FP/PWD, only FP, only PWD)
- Bell Schedule
- Extremely speed verification
- USB flash upgrade firmware
- USB flash export import user information, fingerprint, shifts
- USB flash export attendance report
- T9 input method
- Voice indicate
- All users allowed to query his attendance records



Exit buttons



STP-NT200SS

No touch button with stainless steel shroud

- Infrared No Touch button
- Surface mount
- Illuminated red and green changing LED
- Single gang stainless steel back plate
- Adjustable proximity range
- Adjustable door opening time
- Adjustable LED colour change
- 12/24Vdc
- Single pole double throw
- IP65 (sensor unit only)

Our code:

3925



STP-SPB004S(W)

Surface Weatherproof Green Dome Button

- IP66
- Surface mount
- 4Amps @ 30Vac/dc
- Double pole NO/NC
- Green dome button
- Finger guard
- Change over contacts (NO and NC)

Our code:

3924



STP-SPB004S

Surface Green Dome Stainless Steel Exit Button

- Stainless steel
- Green dome button
- 35mm button
- Change over contact
- Surface mount
- High impact
- Stainless Steel Shroud

Our code:

3923



STP-NT-IP68-B

External IP68 No Touch Exit Button

- Super thin Design reach 14mm depth;
- Black & White Colour is available;
- Dimension: 86 x 86mm
- NO/NC/COM, TOUCHLESS;
- Double Colour LED, Standby Blue Colour, Active Green Colour;
- Sensitive Distance 5~15cm adjustable;
- Time Delay 0~30s adjustable;
- DC 12~24V
- IP68

Our code:

2926

Break Glass Units



STP-CP3-LSRC

Triple pole surface green resettable BGU with LED, sounder and cover

- Triple pole
- Resettable
- Power 12/24vDC
- Adjustable sounder
- Adjustable LED
- Protective cover supplied as standard
- Single gang
- Surface mount
- Size 85mm x 85mm x 42mm (excluding cover)

Our code:

3922



STP-KGG200SG

Double pole surface break glass unit

- Single gang
- Surface mount
- Can be fitted with sounder or buzzer
- Double pole
- Hinged protective cover available (STP-MX03)
- Reset key (STP-KGG-KEY) and replacement glass (STP-KGGGLASS) available

Our code:

3920



STP-KGG1SG

Single pole surface break glass unit

- Single pole
- Hinged protective cover available (STP-MX03)
- Can be fitted with sounder or buzzer
- Reset key (STP-KGG-KEY) and replacement glass (STP-KGGGLASS) available

Our code:

3919



STP-MX03

Protective Cover for GBU 3920 and 3919

- Plastic cover for STP-KGG1SG and STP-KGG200SG

Our code:

3921

Electro-magnetic slim locks



STP-EM01 - 3901
280KG unmonitored slim maglock
12/24Vdc

STP-EM02 - 3903
280KG monitored slim maglock
12/24Vdc - LED

Our code:
3901
3903



STP-EM01DS - 3902
280KG unmonitored slim Maglock
with Door Status Monitoring

STP-EM02DS - 3904
280KG monitored slim maglock
with Door Status Monitoring

Our code:
3902
3904



STP-EM01DS - 3905
280KG Slim unmonitored double
maglock 12/24Vdc

STP-EM02DS - 3906
280KG Slim monitored double
maglock 12/24Vdc

Our code:
3905
3906



STP-EM05DS - 3907
280KG Slim monitored double
maglock with Door Status Monitoring

Our code:
3907

STP-EM OPTIONS



EM320M - 3910
Surface Armature Housing
€8.50



EM300CL - 3909
Adjustable covered L bracket
€22.95



EM300BZL - 3908
Z & L bracket
€14.50

Electro-magnetic midi locks



STP-EM850ZL
360KG External Maglock
Z and L Bracket

- For use on inward-opening doors
- Adjustable for optimal alignment
- Cable-entry slots
- Silver anodised aluminium finish

Our code:
3918

Electro-magnetic standard locks



STP-EM20
500KG Standard monitored
maglock 12/24Vdc - LED

Our code:
3911



STP-EM20DS
500KG Standard monitored
maglock Door Status Monitoring

Our code:
3912



STP-EM30
280KG Slim monitored double
maglock 12/24Vdc

Our code:
3913

STP-EM OPTIONS



EM500ZL - 3914
Z & L bracket: €19.99



EM500CL - 3915
Adjustable covered L bracket: €45.00



EM520M - 3916
Surface Armature Housing: €10.95

Slim mortice maglock



STP-EM00R 280KG Monitored Mortice Maglock

- 12VDC current consumption, 500mA current draw
- 24VDC current consumption, 350mA current draw
- Up to 600lb holding force
- 230 x 38 x 27mm

Our code:
2933

External maglock



STP-EXT800-SLCF 360KG External Maglock

- Weatherproof
- Lock monitored
- Dual voltage
- Side and face fixing
- Stainless steel
- 12Vdc current consumption with 500mA current draw
- 24Vdc current consumption with 250mA current draw
- Up to 360kg holding force
- 20mm female conduit fitting

Our code:
3917

Door loop



STP-SPDL03 Armoured Door Loop

- Cast aluminium alloy ends
- Flexible armoured conduit
- Overall length: 500mm
- Inner diameter: 10mm
- Designed for indoor use only

Our code:
2927

Power Supplies



STP-PAXBOX Access Control 12v 5Amp Boxed PSU Large

- Lockable hinged lid (includes 2 keys)
- Battery back-up (Battery not included)
- LED status indicators
- CE RoHS compliant
- Auto reset
- Surge Protected

Our code:
2932

Electric locking device



STP-ER310-1224 Electric Strike Lock 12/24Vdc

- Ansi style release
- Switchable fail safe / fail secure
- Lip extensions available
- Reversible
- Dual voltage
- 12Vdc current consumption with 250mA current draw
- 24Vdc current consumption with 150mA current draw
- Supplied with both long and short faceplates so suitable for wooden and metal doors
- TIP; Fail safe means when the power is cut the door will open, fail secure means when the power is cut the door will remain shut.

Our code:
2934

Solenoid bolt



STP-EB165 Surface fail safe monitored solenoid bolt

- Fail safe (= power to lock)
- Satin anodised aluminium finish
- Lock monitored
- LED indicator
- Adjustable lock delay: 0 seconds & 3 seconds
- Voltage: 12Vdc

Our code:
3926



PSU5A-12/PSU3A-12/PSU1A-12 Access Control 12v Boxed PSU Small - 5amp / 3amp / 1amp

- 12Vdc
- 5amp (2931)/3amp (2930) 1amp (2628)
- Lockable
- Includes 2 keys
- 265(H) x 195(W) x 75(D)mm
- LED indicators
- Metal hinged box

Our code:
 5amp 3amp 1amp
2931 2930 2928



Video Intercom

IP OUTDOOR STATIONS | IP INDOOR MONITORS | 2-WIRE SERIES | KITS |
VIDEO DOORBELLS

Outdoor stations



VTO7541G Digital Face Recognition Outdoor Station

- Anodized aluminium alloy middle frame
- 8 inch capacitive touch screen and high definition IPS screen; resolution: 800 (H)×1280 (V)
- Face, fingerprint, password, bluetooth, and card unlock
- Face verification accuracy>99%; face comparison time ≤0.3s per person; false recognition rate<0.1%
- Face profiles can be recognized, the profile angle range is 0°–90°
- Support liveness detection
- Full duplex communication
- Outdoor stations can be managed through the platform; voice communication between mobile app and platform
- Support duress alarm, tamper alarm, and fire alarm
- IP66; IK07



Our code:
13094



VTO6221E-P Apartment Outdoor Station

- Small size apartment door station
- Supplemental lighting with white light
- 2MP CMOS camera
- Mechanical button with Braille
- Aluminium alloy plate, IP55, IK08
- Door release via password and Mifare card



Our code:
13077



VTO3221E-P Villa Outdoor Station

- Keyboard villa door station
- Supplemental lighting with white light
- 2MP CMOS camera
- Mechanical button with Braille
- Aluminium alloy plate, IP55, IK08
- Door release via password and Mifare card



Our code:
13074

Outdoor stations



VTO4202F-X Series
Modular Outdoor Station

- Anodized front aluminum panel; IK07
- Supports voice and video communication
- 2 MP high definition fisheye camera with 160° view range
- Access control function; controls two locks
- Compatible with 2-wire interface and RJ45 interface
- Surface mounted & flush mounted



2-wire also available
just add:

- VTNS2003B-2
2-wire Switch
OUR CODE : 13040
- ADS-65LSI-52-1
PSU
OUR CODE : 13041



VTO4202F-P
Camera Module
OUR CODE : 13080



VTO4202F-MB2
2-Button Module
OUR CODE : 13082



VTO4202F-MB5
5-Button Module
OUR CODE : 13084



VTO4202F-MR
Card Reader Module
OUR CODE : 13088



VTO4202F-MK
Keypad Module
OUR CODE : 13086



VTO4202F-MF
Fingerprint Module
OUR CODE : 13087



VTO4202F-ML
Indicator Module
OUR CODE : 13085



VTO4202F-MS
Display Module
OUR CODE : 13083



VTM125
Panel
OUR CODE : 13090



VTM126
Panel
OUR CODE : 13091



VTM127
Mount Box
OUR CODE : 13092



VTM128
Mount Box
OUR CODE : 13093

Outdoor stations

VTO3211D-P-S1/P2-S1/P4-S1 IP 1/2/4-button Villa Outdoor Station



- 2MP HD CMOS camera
- Zinc Alloy panel, IP55, IK08
- ICR Night vision & Voice indication
- Video & Audio messaging
- Remote intercom with mobile APP
- Surface mounted



Our code:

| | | |
|---------|---------|---------|
| 1Button | 2Button | 4Button |
| 13006 | 13003 | 13002 |



VTO2111D-P-S2 IP Villa Door Station



- High definition camera; WDR
- Operating temperature -30°C–60°C
- IP65
- Supports auto IR illumination and D/N
- Card/app remote/indoor monitor unlock
- Supports two-way voice call; support calls between door stations and app 10,000 cards
- Tamper Alarm
- Support standard PoE power supply
- Control two locks

Our code:

13023

VTO2101E-P-S1 IP Villa Outdoor Station



- HD CMOS camera
- Zinc alloy panel, IP65, IK10
- ICR Night vision & Voice indication
- Video & Audio messaging
- TCP/IP, SIP
- Surface mounted



Our code:

13001

VTO2202F-P IP Villa Door Station

2-wire
also available



- 2MP CMOS camera
- Mechanical button
- Night vision & voice indicator
- PoE
- 160° angle of view
- Group call
- Power supply by 2-wire
- Aluminium alloy plate
- IK07, IP65
- Surface mounted and flush mounted

Our code:

13174



VTO2211G-WP IP Villa Wi-Fi Door Station



- Thin lightweight design
- -30°C to +60°C (-22°F to +140°F) operating temperature
- IP65
- IR illumination and night vision
- Card unlock, app unlock, and indoor monitor unlock
- Two-way audio and voice call through app
- Card capacity: 10,000
- Tamper alarm
- Standard PoE
- Control two locks
- Supports wireless network

Our code:

13190



Indoor monitors

VTH5341G-W Android 10-inch digital indoor monitor



- Android 8.1
- More User-Friendly UI
- Ethernet and Wi-Fi
- 10" TFT Capacitive touch Screen, 1024×600
- Micro-SD Card optional, max 256GB
- PoE



VTH5422HB/VTH5422HW 2-wire IP Indoor Monitor **2-wire**

- 7" TFT capacitive touch screen
- 6-channel alarm input and 1-channel alarm output
- Supports standard PoE
- Supports H.265 and H.264 video coding
- Supports 2-wire digital communication
- Power over two-wire switch
- Call management center with one tap
- Supports daisy chain topology
- 2.5D screen glass

Our code:

13178

Our code:

BLACK 13056 WHITE 13057



VTH2421FB(B)-P / VTH2421FB(W)-P Digital VTH (4.3SIP)

- 7" TFT Capacitive touch screen, 1024 x 600
- IPC surveillance
- Alarm integration
- High performance & Cost-effective
- Support 8GB SD card
- Support standard PoE

MOUNTING ACCESSORIES

Optional:



VTH123

Our code:

BLACK 12105 WHITE 12106

VTH5421E(W)-H / VTH5421E(B)-H Digital Indoor Monitor with Handset

- 7 inch LCD, 1024 (H)×600(V)
- 6 alarm input ports
- 1 alarm output port
- 1 12V DC power output port provides power for peripheral alarm devices and sensors
- 16kbps audio stream
- You can answer calls hands free
- Support SOS alarm
- H.264



Our code:

BLACK 13024 WHITE 13042

Outdoor stations/Indoor monitors



VTO2202F-P IP Villa Door Station

- 2MP CMOS camera
- Mechanical button
- Night vision & voice indicator
- PoE
- 160° angle of view
- Group call
- Power supply by 2-wire
- Aluminium alloy plate
- IK07, IP65
- Surface mounted and flush mounted

Our code:

13174



VTH5422HB/VTH5422HW 2-wire IP Indoor Monitor

- 7" TFT capacitive touch screen
- 6-channel alarm input and 1-channel alarm output
- Supports standard PoE
- Supports H.265 and H.264 video coding
- Supports 2-wire digital communication
- Power over two-wire switch
- Call management center with one tap
- Supports daisy chain topology
- 2.5D screen glass

Our code:

BLACK 13056 WHITE 13057



VTNS2003B-2 2-wire Switch

- Supports 10-level cascade through the 2-wire port
- Supports connecting to 20 indoor monitors and 2 door stations
- Supports connecting through RJ45 port

Our code:

13040



Our code:

13041

ADS-65LSI-52-1 2-wire controller PSU adapter

- For network switch
- Power supply type: Indoor
- AC-to-DC
- Cable length 1.5 m
- Input current: 1.5 A, Input voltage: 100 - 240 V
- Output power: 60 W, Output voltage: 24 V, Output current: 2.5 A

kit

2-wire



DHI-KTD01S 2-wire IP Villa Door Station kit + Surface base

- Anodized aluminum front panel
- CMOS low illumination 2MP HD colorful 160° fisheye camera
- Video intercom function
- Access control function that supports for two locks
- Mobile phone app, talk to the visitor or unlock the door remotely on
- Compatibility 2-wire Interface & RJ45 Interface
- IK07&IP65
- Support H.265
- Surface mount
- PoE
- 2.5D screen glass
- 7" TFT capacitive touch screen
- 6-channel alarm input and 1-channel alarm output
- Supports standard PoE OR Power over 2-wire switch
- H.265 video coding (H.264 by default)
- Supports 2-wire digital communication
- Supports daisy chain topology
- Supports 10-level cascade through the 2-wire port
- Supports connecting to 20 devices
- Supports connecting through RJ45 port
- Supports guide rail mount

Our code:

13205

Kits



Our code:

SURFACE

FLUSH

13097

13204

DHI-KTP01S / DHI-KTP01F (Surface or flush mounted) IP Villa Outdoor Station & Indoor Monitor kit

IP Villa Door Station :

- 2MP CMOS camera
- Mechanical button
- Night vision & voice indicator
- 160° angle of view
- Group call
- Aluminium alloy plate
- IP55&IK07
- Surface or flush mounted
- Support standard PoE

IP Indoor Monitor :

- IPC surveillance
- Alarm integration
- High performance
- Embedded 8GB SD card
- Support standard PoE

4-Port PoE Switch :

- RJ45 port supports 10/100Mbps self-adaptation
- Supports 250 meters long distance PoE transmission



Our code:

13071

DHI-KTP02

IP Villa Door Station & Indoor Monitor kit

IP Villa Door Station :

- High definition camera; WDR
- Operating temperature -30°C to 60°C
- IP65(Silicone sealant is needed. For details, see the quick start guide.)
- Supports auto IR illumination and D/N
- Card/app remote/indoor monitor unlock
- Supports two-way voice call; support calls between door stations and app
- 10,000 cards
- Tamper Alarm
- Support standard PoE power supply
- Control two locks

IP Indoor Monitor :

- IPC surveillance
- Alarm integration
- High performance
- Embedded 8GB SD card
- Support standard PoE
- Quick configuration without computers

Video Doorbell



Our code:

13031

DB11

WiFi Video Doorbell

- Operates up to 5 months on a single charge
- Wire-free installation
- Up to 1080P HD video talk with 140° horizontal angle
- IR powered night vision
- PIR detection with 5 configurable zones
- Cloud talk, cloud storage



Our code:

13032

DS11

Doorbell Chime

- Multiple ring tones
- Mobile application
- Plug & play
- Easy to install (Wi-Fi connection)
- Only works as an extra unit with DB11





Gate automation

UNDERGROUND & OVERGROUND SWING GATES | SLIDING GATES | BARRIERS |
ACCESSORIES

DEA System

DEA at a glance



1993

DEA System comes to life

The company was established in Italy. DEA's vision has always been multinational from the very beginning of its activities. They exported their challenge and values almost 30 years ago, becoming a company highly renowned and appreciated worldwide for its quality automation products.

8 branches have been opened since 2012: this is the result of the increasing need for local resource and capability, coming from the positive feedback received by the international markets. Six branches in France, two in the UK, one in Germany, Spain, Portugal, Belarus and Poland, and one branch in Italy contribute to the promotion of the DEA brand, while guaranteeing and protecting the quality of its products.





In-house development & production

DEA create products and systems for the automation of buildings and public spaces able to interact in a simple and smart way with professionals and end users

People and passion are at the heart of their activities, and thanks to the commitment of each person, they design and manufacture products that will be used every day by thousands of people all over the world

Italian Know-How

Since 2013, the group has become stronger thanks to the collaboration with DEA HT, the high technology division dedicated to the development and production of electronic components. 40 people who design, engineer, prototype and test the electronic elements that manage our automations.

The centralization of all the development phases allows DEA to have full control over the entire production and distribution process. DEA design, produce and assemble both the mechanic and electronic components of their products. This is crucial to guarantee the quality of each component, especially when technology is connected to people's safety.

Each DEA product is totally conceived and developed in-house. DEA HT, design and produce the electronic components controlling DEA's automations.



AUTHORISED DISTRIBUTOR

Since 2020, KD Electronics became an authorised DEA distributor. We stock and deliver across Ireland, automations for residential, collective and industrial gates*.

***Please note that all the individual parts of each kit can be purchased separately. Visit www.kdelectronics.ie to view the full range**

**European
know-how & production**

DEA technology

Netlink NETLINK is the new DEA technology that allows you to manage your installations from your smartphone, in an easy and smart way.



Net-Com

Remote maintenance of the DE@NET control units:

- Check the correct operation of the system.
- Read and modify the parameters of the installations.
- Consult the log of the events registered by the control unit.

The advanced access control

- Enable up to 1,500 remotes per time band and consult the access register.
- Set automatic openings and closings programmes with a yearly calendar.
- Activate the gate with a mobile phone call.
- Check the gate state and control the automation remotely using the DEAUser app.
- Connect NET-COM to control units by other manufacturers and exploit the potential of the advanced access control.

In order to use NETLINK you must link up NET-NODE to the compatible control boards and associate it to the DE@nStaller App.

Compatible devices report a unique serial number of 10 digits (eg: 00 02 00 AB F5) that identifies the type of card and will be recognized during the scan of the App.

NET-NODE

NET-NODE is the module to be wired to DE@NET devices (control units and receivers) that enables the wireless programming of the installation thanks to the DE@nStaller App.

If left connected to the control board, it also enables you to control the automation with DE@user App.

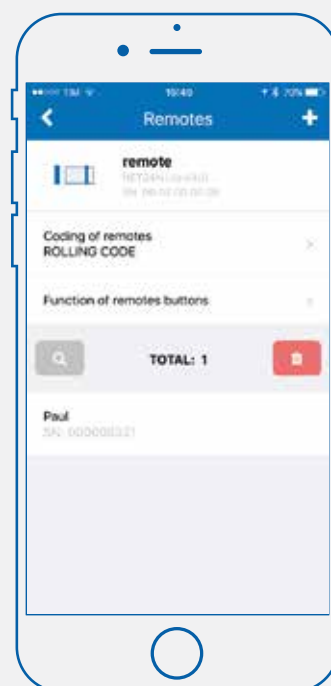
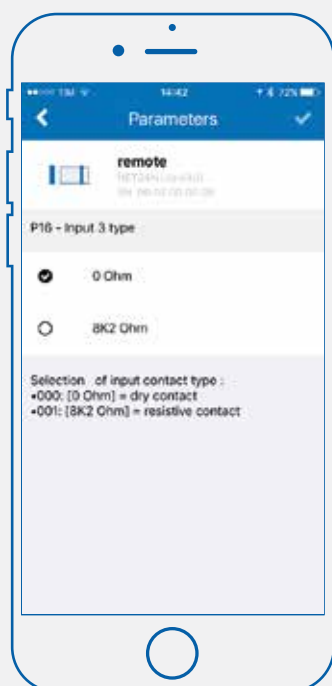

Control test of accessories, both incoming and outgoing (photocells, safety edges, electric locks, flashing lights...)

Managing parameters:

- Consultation and summary of the settings
- Parameters description
- Values ajustement

Management of the remote controls:

- Remote controls encoding setting.
- Saving new remotes.
- Remove existing remotes.

Easy installation, smart management

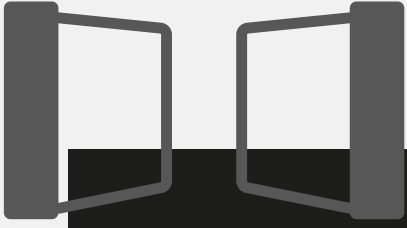

SWINGING GATES



Electromechanical automation for swinging gates





Compatible with the Apps
DEAinstaller and DEAusser

Ghost Series

Ghost 100 - Ghost 200



Electromechanical underground automation for swing gates

| TECHNICAL INFO | 100/CL - 100EN/CL | 100/24CL |
|-------------------------------|-------------------------|----------|
| Motor power supply (V) | 230V ~± 10 % (50/60 Hz) | 24V |
| Maximum power absorption (W) | 250 | 50 |
| Max torque (Nm) | 250 | 200 |
| Duty cycle (cycles/hours) | 18 - 25 (vers. 100EN) | 40 |
| N. max cycles in 24h. | 100 | |
| Built-in capacitor (µF) | 10 | / |
| Operating temperature (°C) | -20 ÷ 50 | |
| Motor thermal protection (°C) | 150 | / |
| 90° Opening time (s) | 16 | 14 |
| Weight with packing (Kg) | 11 | |
| Sound pressure (dBA) | < 70 | |
| Protection level | IP67 | |

| TECHNICAL INFO | 200CL | 200L/CL | 200/24CL |
|-------------------------------|-------------------------|---------|----------|
| Motor power supply (V) | 230V ~± 10 % (50/60 Hz) | | 24V |
| Maximum power absorption (W) | 400 | 330 | 150 |
| Max torque (Nm) | 320 | 300 | 210 |
| Duty cycle (cycles/hours) | 20 - 28 | 18 | 40 |
| N. max cycles in 24h. | 200 | 280 | |
| Built-in capacitor (µF) | 12,5 | / | |
| Operating temperature (°C) | -20 ÷ 50 | | |
| Motor thermal protection (°C) | 150 | / | |
| 90° Opening time (s) | 17 | 26 | 16 |
| Weight with packing (Kg) | 14,5 | 14 | |
| Sound pressure (dBA) | < 70 | | |
| Protection level | IP67 | | |

Product kits*

Each kit includes:



1x Flashing light



2x Remote control



1x Control Board



1x Pair of photocell

+ 2x Ghost 100 or Ghost 200 operators



GHOST 100 KIT 230V

Code: 30007

100/CL

- Up to 3,5m - 400kg
- 230V
- Use intensity: residential - Motor controlled by encoder
- Foundation box included
- Integrated mechanical stops (standard)
- Leaf opening up to 180° with art. 116GN
- Monobloc, aluminium structure



GHOST 100 KIT 24V

Code: 30008

100/24CL

- Up to 3,5m - 400kg
- 24V
- Use intensity: semi-intensive
- Foundation box included
- Integrated mechanical stops (standard)
- Leaf opening up to 180° with art. 116GN
- Monobloc, aluminium structure



GHOST 200 KIT 230V

Code: 30009

200CL

- Up to 4m - 400kg
- 230V
- Use intensity: semi-intensive
- Foundation box included
- Mechanical stops sold separately
- Leaf opening up to 180° with art. 116GN
- Monobloc, aluminium structure



GHOST 200 KIT 24V

Code: 30010

200/24CL

- Up to 4m - 400kg
- 24V
- Use intensity: intensive
- Foundation box included
- Mechanical stops sold separately
- Leaf opening up to 180° with art. 116GN
- Monobloc, aluminium structure



Compatible with the Apps
DEAinstaller and DEAuser

Mac & Livi 502 Series

**Residential
use**

**Electromechanical arm/ram
for overground swing gates**



| TECHNICAL INFO | MAC | MAC24 |
|-------------------------------|--------------------------|-------|
| Motor power supply (V) | 230V ~ ± 10 % (50/60 Hz) | 24V |
| Maximum power absorption (W) | 300 | 60 |
| Max thrust (N) | 1650 | 1000 |
| Time with total stroke (s) | 21 | 22 |
| 90° Opening time (s)* | 16 | |
| Duty cycle (cycles/hours) | 18 | 40 |
| N. max cycles in 24h | 90 | |
| Built-in capacitor (µF) | 8 | / |
| Operating temperature (°C) | -20 ÷ 50 | |
| Motor thermal protection (°C) | 150 | / |
| Weight with packing (Kg) | 8,8 | |
| Sound pressure (dBA) | < 70 | |
| Protection level | IPX4 | |

*the opening time of the leaf at 90° may be lower accordingly to the geometry of the installation

| TECHNICAL INFO | LIVI 502 | LIVI 502/24 |
|-------------------------------|--------------------------|-------------|
| Motor power supply (V) | 230V ~ ± 10 % (50/60 Hz) | 24V |
| Maximum power absorption (W) | 300 | 80 |
| Max torque (Nm) | 295 | 180 |
| Duty cycle (cycles/hours) | 22 | 35 |
| N. max cycles in 24h | 110 | 140 |
| Built-in capacitor (µF) | 8 | / |
| Operating temperature (°C) | -20 ÷ 50 | |
| Motor thermal protection (°C) | 150 | / |
| 90° Opening time (s)* | 12 | 10 |
| Weight with packing (Kg) | 13,5 | 13,2 |
| Sound pressure (dBA) | < 70 | |
| Protection level | IP44 | |

Product kits*

Each kit includes :



1x Flashing light



2x Remote control



1x Control Board



1x Pair of photocell

+ 2x LIVI 502 or MAC operators

LIVI 502: for large-sized swing gates



LIVI 502 KIT 230V

Code: 30036

502

- For leaves up to 3 mt long.
- 230V
- Use intensity: residential
- Possibility to use horizontal or vertical fixing plates (optional)
- Quick release with customised metal key
- Perfect for larger size pillars

MAC: for small and lightweight swing gates



LIVI 502 KIT 24V

Code: 30037

502/24

- For leaves up to 3 mt long.
- 24V
- Use intensity: semi-intensive
- Possibility to use horizontal or vertical fixing plates (optional)
- Quick release with customised metal key
- Perfect for larger size pillars



MAC KIT 230V

Code: 30015

MAC

- For leaves up to 3 mt long.
- 230V
- Use intensity: residential - stroke 334mm
- Self-locking operators
- Mechanical stops available in open and close position (optional)
- Robust structure, monobloc aluminium
- Adjustable fixing plate (included)



MAC KIT 24V

Code: 30016

MAC24

- For leaves up to 3 mt long.
- 24V
- Use intensity: semi-intensive - stroke 334mm
- Self-locking operators
- Mechanical stops available in open and close position (optional)
- Robust structure, monobloc aluminium
- Adjustable fixing plate (included)



Oli Series

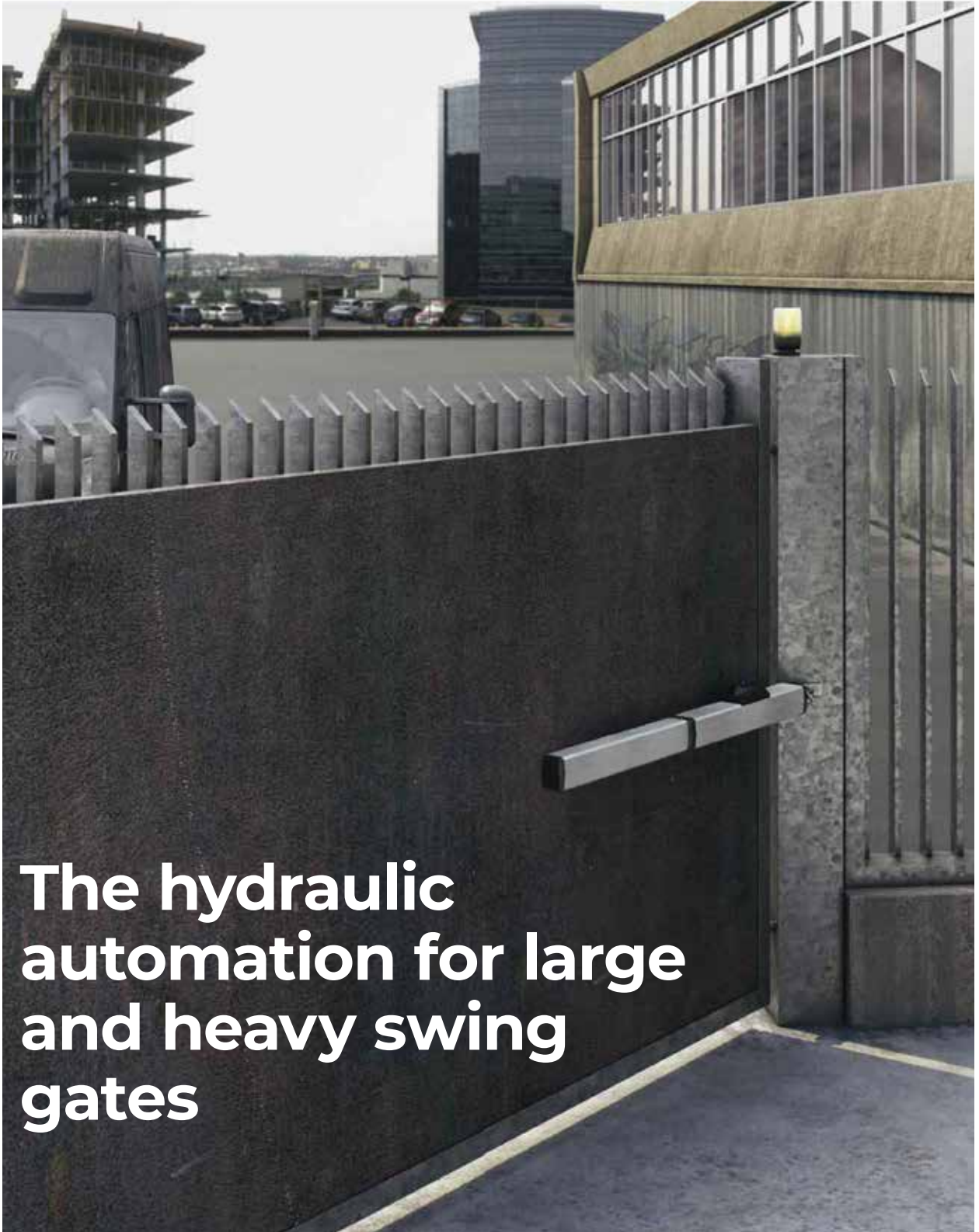

The hydraulic automation for large and heavy swing gates

Product kits*

Each kit includes:



| TECHNICAL INFO | OLI 603 | OLI 605 |
|-------------------------------|--------------------------|---------|
| Motor power supply (V) | 230V ~ ± 10 % (50/60 Hz) | |
| Maximum power absorption (W) | 170 | |
| Max thrust (N) | 3980 | |
| Max traction force (N) | 3200 | |
| Duty cycle (cycles/hours) | 60 | 50 |
| N. max cycles in 24h. | 480 | 400 |
| Built-in capacitor (µF) | 8 | |
| Operating temperature (°C) | -20 ÷ 50 | |
| Motor thermal protection (°C) | 130 | |
| 90° Opening time (s) | 21 | 31 |
| Weight with packing (Kg) | 11,4 | 13 |
| Sound pressure (dBA) | < 70 | |
| Protection level | IP55 | |

Used Oil: AGIP Arnica A15



OLI 603 KIT 230V

Code: 30021

OLI603

- For leaves up to 2 mt long.
- 230V
- Use intensity: intensive - Stroke 270 mm
- Self-locking in open and close position
- Quick release with customised metal key
- Adjustable fixing plate (included)

OLI 605 KIT 230V

Code: 30022

OLI605

- For leaves up to 2,5 mt long.
- 230V
- Use intensity: intensive - Stroke 400 mm
- Self-locking in open and close position
- Quick release with customised metal key
- Adjustable fixing plate (included)



SLIDING GATES



Automation for residential sliding gates





Compatible with the Apps
DEAinstaller and DEAusser



Livi/N Series

**Residential
use**



Control board positioned in a lifted position at the front. Always accessible and perfect for small or narrow spaces



Battery kit with dedicated support (optional and only for 24V models)

Dedicated support for bluetooth device NET-NODE



Models available with magnetic limit switches

Invisible fixing system, with threaded rod

Compatible with external unlocking device by cable (art. 450N to be used with BLINDOS - optional)



NETLINK OPERATOR
This operator is compatible with the NETLINK System and can be programmed with DEAInstaller and NET-COM

(Only versions with NET24N, NET230N, or NET724N)

| TECHNICAL INFO | LIVI 6N | LIVI 9N | LIVI 6/24N/F-BOOST | LIVI 9/24N/F |
|-------------------------------|---|---------|--------------------|--------------|
| Motor power supply (V) | 230V ~±10% (50/60 Hz) | | 24V | |
| Maximum power absorption (W) | 320 | 450 | 80 | 110 |
| Max thrust (N) | 340 | 490 | 240 | 260 |
| Duty cycle (cycles/h)* | 18 | 11 | 22 | 18 |
| N. max. cycles in 24h* | 60 | 40 | 60 | 40 |
| Built-in capacitor (µF) | 8 | 12,5 | \ | |
| Operating temperature (°C) | -20 ÷ 50 | | | |
| Motor thermal protection (°C) | 140 | 160 | \ | |
| Speed (m/min) | 10 | | 16 | 10 |
| Standard pinion | Z16 | Z16 | Z16 | Z16 |
| Weight with packing (Kg) | 11 | 12,5 | 12 | |
| Sound pressure (dBA) | < 70 | | | |
| Protection level | IPX4 (IP44 for versions with magnetic limit switches) | | | |

* For a 5m leaf length

Product kits*

Each kit includes:



1x Flashing light



2x Remote control



1x Control Board



1x Pair of photocell

+ 1x LIVI/N operator



LIVI 6N KIT 230V

Code: 30011

LIVI 6N

- For gates up to 600 Kg
- 230V
- Small, perfect for tiny spaces
- Silent, motor control by encoder and obstacle detection
- Quick release with customised metal key
- Robust and reliable, anti-crushing safety device.
- Fixing plate included



LIVI 9N/M KIT 230V

Code: 30012

LIVI 9N/M

- For gates up to 900 Kg
- 230V
- Small, perfect for tiny spaces
- Silent, motor control by encoder and obstacle detection
- Quick release with customised metal key
- Robust and reliable, anti-crushing safety device.
- Fixing plate included



LIVI 6/24N/F-BOOST KIT 24V

Code: 30013

LIVI 6/24N/F-BOOST

- For gates up to 600 Kg
- 24V
- Small, perfect for tiny spaces
- Silent, version with increased speed
- Quick release with customised metal key
- Robust and reliable, anti-crushing safety device.
- Fixing plate included



LIVI 9/24N/F KIT 24V

Code: 30014

LIVI 9/24N/F

- For gates up to 900 Kg
- 24V
- Small, perfect for tiny spaces
- Silent
- Quick release with customised metal key
- Robust and reliable, anti-crushing safety device.
- Fixing plate included



BARRIERS



Electromechanical barriers





Pass Series

Electromechanical barrier up to 3m of boom length for apartment or private contexts

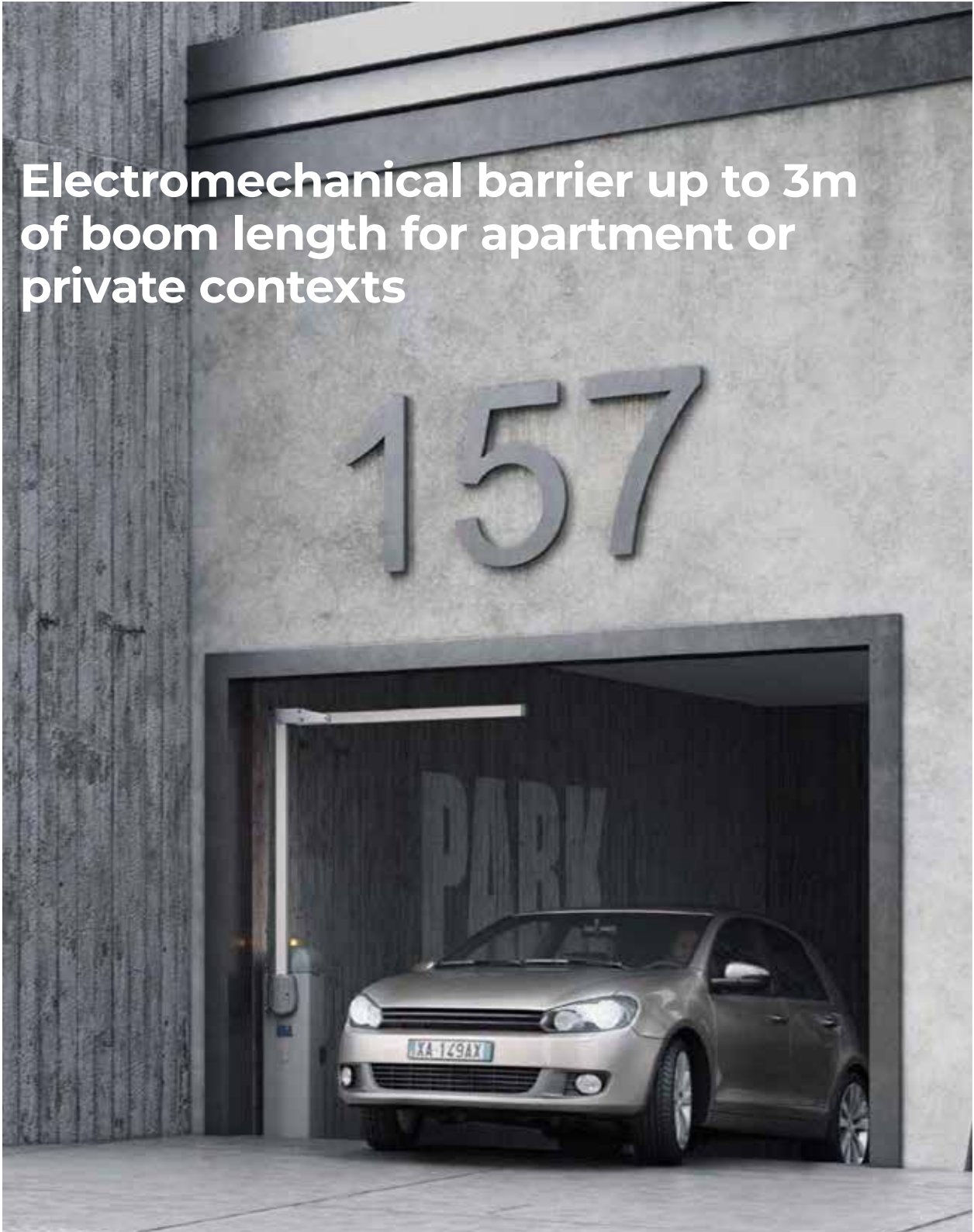

Products

Residential & semi-intensive use

PASS BARRIER 24V

Code: 30023

PASS24NET/V

- Speed adjustment during normal cycle and slow down in opening and closing
- Motor control by encoder and obstacle detection
- Possibility to lock the programming to prevent tampering
- Control board 24V
- For booms up to 3mt
- For residential and semi-intensive use

(Barrier only - Boom sold separately)

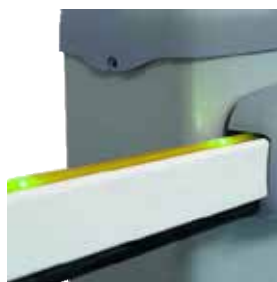

| TECHNICAL INFO | PASS24NET/V |
|------------------------------|-------------|
| Motor power supply (V) | 24V |
| Maximum power absorption (W) | 105 |
| Duty cycle (cycles/hours) | 290 |
| N. max cycles in 24h. | 800 |
| Operating temperature (°C) | -20 ÷ 50 |
| 90° Opening time (s) | 2,2 |
| Weight with packing (Kg) | 41 |
| Sound pressure (dBA) | < 70 |
| Protection level | IPX4 |



Compatible with the Apps
DEAinstaller and DEAuser

Stop N Series

STOPN:
companies
& large car
parks

Full access to internal mechanical and electrical components thanks to the presence of two doors and a removable cover

Suitable for locations with heavy traffic, such as car parks, commercial areas, industrial sites

Flexible and quick during installation thanks to the double output of the shaft which allows you to install the rod in both sides

Easy adjustment of the closing and opening position thanks to the electromechanical limit switches

Possibility of installing an additional limit switch to signal the status of the barrier



Operator in oil bath to ensure longer life

High resistance to corrosion with the case with cathaphoresis treatment and polyester powder coating



The DE@NET universal control board makes this operator compatible with NETLINK System.



Compatible with NETCOM, the device for installation maintenance and remote control management!

The combination of inverter technology and encoder guarantees greater control, smoothness and safety in movement

Electromechanical barrier up to 8m of boom length

| TECHNICAL INFO | STOPNET/NL-F | | STOP24NET/NV-F | STOP24NET/NL-F | |
|-------------------------------|--------------------------|--------|----------------|----------------|--------|
| Boom length | 4 - 6m | 6 - 8m | 4m | 4 - 6m | 6 - 8m |
| Motor power supply (V) | 230V ~ ± 10 % (50/60 Hz) | | | 24V | |
| Maximum power absorption (W) | 500 | | | 120 | |
| Duty cycle (cycles/hours) | 150 | 125 | 500 | 250 | 170 |
| N. max cycles in 24h. | 800 | 500 | 1500 | 1000 | 800 |
| Built-in capacitor (µF) | 18 | | | / | |
| Operating temperature (°C) | | | (-20°) - (50°) | | |
| Motor thermal protection (°C) | 150 | | | / | |
| 90° Opening time (s) | 6,5 | 8 | 2,7 | 5,3 | 7,5 |
| Weight with packing (Kg) | 81 | | | 79 | |
| Sound pressure (dBA) | | | < 70 | | |
| Protection level | | | IPX4 | | |

Products



STOP N 230V 6 - 8M SLOW

Code: 30130

STOPNET/N/L-F

- Electromechanical limit switches integrated
- Supplied with 4 springs
- Motor control by encoder and obstacle detection

(Barrier only - Boom sold separately)

STOP N 24V 4M FAST

Code: 30131

STOP24NET/N/V-F

- Electromechanical limit switches integrated
- Supplied with 4 springs
- Supplied with 2 springs
- Motor control by encoder and obstacle detection

(Barrier only - Boom sold separately)

STOP N 24V 6 - 8M SLOW

Code: 30132

STOP24NET/N/L-F

- Electromechanical limit switches integrated
- Supplied with 4 springs
- Motor control by encoder and obstacle detection

(Barrier only - Boom sold separately)

Example of a typical installation



COD. 645051
Art. STOP24NET/N/L-F
Electromechanical barrier



COD. 649290
Art. TRAFIK/LED
LED strip for top of the barrier case
Consumption: min. 184 mA - max. 552 mA. To be used with cod. 163623 NET-COM POWER SUPPLY



COD. 649270
Art. OMEGA
Boom holder for DEA booms art. BOOM4 and art. BOOM6



COD. 321810
Art. GSOFTP
Black rubber profile, EPDM S65 (24m)



COD. 649261
Art. BOOM6
DEA round painted boom 6125xØ60mm, with reflective red stickers art. 1012



COD. 662044
Art. LINEAR
A pair of (180°) adjustable photocells with the range of 20m. (Enabling synchronized operating).



COD. 649072
Art. STOP/B
Foundation plate



COD. 672645
Art. GTI4
Serialized white 4-channel remote control, 433 MHz, with 3 coding: HCS Rolling-Code, Dip-Switch and new D.A.R.T. coding



COD. 649000
Art. 1006
Mobile boom support



COD. 664000
Art. PILLY/60
55cm column for photocell (2 pcs)



COD. 649160
Art. BSF
Bracket for LINEAR photocells



COD. 668010
Art. 127
Warning sign

Accessories



230V CONTROL PANEL W/ BOX

Code: 30000

Art. NET230N/C

- For 1 or 2 operators in 230V
- Possibility to select the type of installation
- Possibility of adjustment of more than 99 operating parameters
- Simplified learning procedure
- 433 MHz radio receiver for up to 100 remote controls

230V FLASHING LIGHT LED

Code: 30032

Art. AURA230

- 230V flashing light LED
- With integrated antenna
- 433 MHz
- Cable L=5m (85xh140x42mm)

24V FLASHING LIGHT LED

Code: 30033

Art. AURA24

- 24V flashing light LED
- With integrated antenna
- 433 MHz
- Cable L=5m (85xh140x42mm)



EXTENSION FOR MAC/ STING AND LOOK ARMS

Code: 30018

Art. MAC-LOOK/P



MECHANICAL STOPS FOR MAC/STING

Code: 30019

Art. MAC/FM



ADJUSTABLE FIXING PLATES

Code: 30020

Art. MLS/SFR



HARDWIRED 2 CHANNEL RECEIVER 433MHZ

Code: 30027

Art. 281/2

- Capacity to store 1000 transmitters and button assignment independently for each transmitter and relay
- Power 24V AC/DC
- Maximum contact rating 0,5A/30Vdc



HARDWIRED 2 CHANNEL RECEIVER 868MHZ

Code: 30028

Art. 281/2/868

- Capacity to store 1000 transmitters and button assignment independently for each transmitter and relay
- Power 24V AC/DC
- Maximum contact rating 0,5A/30Vdc



COVER BOX FOR 281/2

Code: 30029

Art. 100F

- For indoor installation

Accessories



DIGIKEY WITH CABLE AND PROXIMITY READER
Code: 30003

Art. DIGIPRO

- Ability to record more than 1000 proximity cards or tokens
- Backlit for a better use at night-time
- Fit for any outdoor installation
- Power supply 12-24V



SLIM DIGIKEY WITH CABLE AND PROXIMITY READER
Code: 30004

Art. DIGISLIM

- Ability to record more than 1000 proximity cards or tokens
- Backlit for a better use at night-time
- Fit for any outdoor installation
- Power supply 12-24V



SURFACE MOUNTED ADJUSTABLE PHOTOCELLS
Code: 30002

Art. LINEAR

- Pair of adjustable photocells (180°) with possibility of synchronized operating
- Range 20m



ADJUSTABLE PHOTOCELLS WITH BATTERY
Code: 30030

Art. LINEAR/B

- Pair of adjustable photocells (180°) with tx supplied by a lion battery
- Range 7/15m



COLUMN FOR PHOTOCELLS
Code: 30031

Art. PILLY/60

- 55cm column for photocell (2 pcs)



WARNING SIGN
Code: 30035

Art. 127

- English warning sign



230V LED TRAFFIC LIGHT
Code: 30005

Art. SMFLED230/2
• 230V led traffic light: red-green lights



24V LED TRAFFIC LIGHT
Code: 30006

Art. SMFLED24/2
• 24V led traffic light: red-green lights

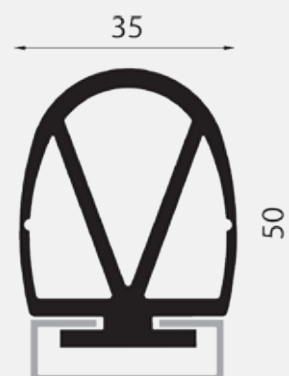

SAFETY RUBBER PROFILE
Code: 30034

Art. SOFT3
Safety black rubber profile (complete with aluminium base) useful to reduce the impact forces for sliding and swing gates (12m)



2 CHANNELS REMOTE FOB
Code: 30001

Art. GTI2
• CR2032 lithium battery
• 433,92 MHz
• Range: 250-300m
• 2 channels
• Encoding: HCS rolling-code, Dip-Switch, D.A.R.T.
• Not copyable



4 CHANNELS REMOTE FOB
Code: 30026

Art. GTI4
• CR2032 lithium battery
• 433,92 MHz
• Range: 250-300m
• 4 channels
• Encoding: HCS rolling-code, Dip-Switch, D.A.R.T.
• Not copyable

Accessories



1-CHANNEL MAGNETIC LOOP DETECTOR

Code: 30052

Art. LOOP230/1

Magnetic device to which a loop is connected to detect the presence of metal masses in a given passage. Once the mass is detected, for example a car or a motorcycle, the detector sends the set command to the control unit.



2-CHANNEL MAGNETIC LOOP DETECTOR

Code: 30056

Art. LOOP230/2

This version allows the connection of two loops, so that you can

- control two separate but close automations (e.g. two opposite barriers for entry and exit of vehicles)
- give two commands to the same automation (e.g. opening before the passage of a vehicle and closing after it).



DYNAMITE MINI-LOOP KIT (PULSE ONLY)

Code: 30039

ACC/LOOP/MINI

- Exit Sensor with 22m Fly Lead & Module
- Pulse Only Sensor
- The 'Dynamite' mini loop is a unique vehicle detector device in a 22mm diameter tube.
- An integral ground cable runs back to a module in your control panel. Dynamite gives a pulse output when a vehicle drives over.



DYNAMITE MINI-LOOP KIT (PRESENCE)

Code: 30040

ACC/LOOP/PRESENCE

- Exit Sensor with 22m Fly Lead & Module
- It is a 'presence' sensor
- The 'Dynamite' mini loop is a unique vehicle detector device in a 22mm diameter tube.
- An integral ground cable runs back to a module in your control panel. The sensor recognizes vehicles by the ferrous content of the car.



Intruder alarms

ALARM KITS | KEYPADS | PANELS | WIRED & WIRELESS PIRs | WIRED & WIRELESS CONTACTS
& SENSORS | SOUNDERS | DIALLERS & COMMUNICATORS | EXPANDERS | ACCESSORIES

With Texecom you have the possibility to customise your alarm keypads, your sounder covers and your wall mount Capture PIRs with your logo (Please contact us for customisation)

Personalised company emblems

KEYPAD



Odyssey X graphic inserts

SOUNDER



Customise your Capture

PIR



Texecom's electronic security products and services protect millions of people and properties around the world.

Texecom is Europe's largest independent security alarm specialist providing bespoke design solutions that protect people and property throughout the world. Texecom's award-winning products cover every aspect of external and internal security requirements, including a full range of motion detectors, control panels, perimeter protection devices, fire detectors and external sounders. Texecom launched a ground breaking wireless technology, Ricochet mesh networking, to universal acclaim.

Complete control for all aspects of development is ensured through design, manufacture and thorough testing of all products in state-of-the-art UK facilities.

Texecom is firmly committed to providing products that exceed the demands of European and international standards. Texecom prides itself on producing innovative products, designed to exceed expectations. Every product within the range is fully compliant with the requirements of the latest European Standards.

Digital services

Texecom's range of digital services add value, improve efficiency, and delight users in every step of the intruder protection journey. Texecom Connect opens a new world of possibilities for Texecom security systems. For too long, security systems have been separated and isolated from the outside world - only providing information when the worst happens, confusing and intimidating the very people who use them and lacking connectivity and compatibility with external systems that could benefit from the intelligence and information contained within.

With Texecom Connect, everything changes.



System Users

Interact, control and integrate your Premier Elite security system like never before. Texecom Connect lets you take direct control of your alarm system from a tablet or smartphone device - from anywhere in the world.



Alarm Companies

Texecom Cloud provides your business the tools to manage, configure and control your alarm system and Texecom Connect app portfolio.



Engineers

Make sure your field engineers and technicians have downloaded TexecomPro, the free app for iOS and Android that provides support and product information all at the touch of a button.

Wireless Kits



KIT-1001

64 Zone Wireless Kit

- 1 x Premier Elite 64-W
- 5 x Premier Proximity Tags
- 1 x Premier Elite LCDLP-W
- 3 x Capture P15-W
- 1 x Premier Elite Micro Contact-W

Our code:

6797



KIT-1002

64 Zone Wireless Kit with Sounder

- 1 x Premier Elite 64-W
- 5 x Premier Proximity Tags
- 1 x Premier Elite LCDLP-W
- 3 x Capture P15-W
- 1 x Premier Elite Micro Contact-W
- 1 x Odyssey X-W Backplate

Our code:

6799



KIT-1086

64 Zone Wireless Kit with Wired Keypad

- 1 x Premier Elite 64-W
- 5 x Premier Proximity Tags
- 1 x Premier Elite LCDLP
- 3 x Capture P15-W
- 1 x Premier Elite Micro Contact-W

Our code:

6798



KIT-1005

32 Zone Hybrid Wireless Kit

- 1 x Premier Elite 48
- 1 x Premier LCDP
- 5 x Proximity Tags
- 1 x Premier Elite 32XP-W
- 2 x Capture Q20-W
- 2 x Capture D20-W
- 2 x Impaq SC-W

Our code:

6648



KIT-1003

64 Zone Self Contained Wireless Kit

- 1 x Premier Elite 64-W LIVE
- 2 x Premier Elite SmartKey
- 3 x Capture P15-W
- 1 x Premier Elite Micro Contact-W

Our code:

6793



KIT-1004

64 Zone Self-Contained Wireless Kit with Sounder

- 1 x Premier Elite 64-W LIVE
- 2 x Premier Elite SmartKey
- 3 x Capture P15-W
- 1 x Premier Elite Micro Contact-W
- 1 x Odyssey X-W Backplate

Our code:

6794



DBA-0001
Premier LCD Iconic Keypad

- Premier Elite Series Compatible
- Green LCD Screen
- Touchtone Keys
- Backlighting
- 2 Additional Zones
- 1 Programmable Output
- PD6662:2017 Grade 3 Class II

Our code:
6690



DBB-0001
Premier LCDL Iconic Keypad

- Premier Elite Series Compatible
- Green LCD Screen
- Touchtone Keys
- Backlighting
- 2 Additional Zones
- 2 Programmable Outputs
- Extension Speaker
- PD6662:2017 Grade 3 Class II

Our code:
6691



DBD-0168
Premier Elite LCDLP Keypad

- Premier Series Compatible
- Blue LCD Screen
- Touchtone Keys
- Backlighting
- 2 Additional Zones
- 1 Programmable Output
- Extension Speaker
- Built-in Proximity Tag Reader
- PD6662:2017 Grade 3 Class II

Our code:
6694



DBD-0124/DBD-0130
Premier Elite FMK/SMK Diamond Black Flush or Surface mounted

- Premier Series Compatible
- Blue LCD Screen
- Touchtone Keys
- Backlighting
- 2 Additional Zones
- 1 Programmable Output
- Extension Speaker
- Built-in Proximity Tag Reader
- PD6662:2017 Grade 3 Class II

Our code:
Flush: 6686

Surface: 6680



DBD-0125/DBD-0131
Premier Elite FMK/SMK Gunmetal Flush or Surface mounted

- Premier Series Compatible
- Blue LCD Screen
- Touchtone Keys
- Backlighting
- 2 Additional Zones
- 1 Programmable Output
- Extension Speaker
- Built-in Proximity Tag Reader
- PD6662:2017 Grade 3 Class II

Our code:
Flush: 6687

Surface: 6681



DBD-0123/DBD-0129
Premier Elite FMK/SMK Satin Chrome Flush or Surface mounted

- Premier Series Compatible
- Blue LCD Screen
- Touchtone Keys
- Backlighting
- 2 Additional Zones
- 1 Programmable Output
- Extension Speaker
- Built-in Proximity Tag Reader
- PD6662:2017 Grade 3 Class II

Our code:
Flush: 6685

Surface: 6679



DBD-0121/DBD-0127
Premier Elite FMK/SMK Polished Chrome Flush or Surface mounted

- Premier Series Compatible
- Large Blue LCD Screen
- Touchtone Keys
- Backlighting
- 2 Additional Zones
- 1 Programmable Output
- Extension Speaker
- Built-in Proximity Tag Reader
- PD6662:2017 Grade 3 Class II

Our code:
Flush: 6683

Surface: 6677



DBD-0170/DBD-0171
Premier Elite FMK/SMK Diamond White Flush or Surface mounted

- Premier Series Compatible
- Blue LCD Screen
- Touchtone Keys
- Backlighting
- 2 Additional Zones
- 1 Programmable Output
- Extension Speaker
- Built-in Proximity Tag Reader
- PD6662:2017 Grade 3 Class II

Our code:
Flush: 6688

Surface: 6682



DBD-0122/DBD-0128
Premier Elite FMK/SMK Polished Brass Flush or Surface mounted

- Premier Series Compatible
- Large Blue LCD Screen
- Touchtone Keys
- Backlighting
- 2 Additional Zones
- 1 Programmable Output
- Extension Speaker
- Built-in Proximity Tag Reader
- PD6662:2017 Grade 3 Class II

Our code:
Flush: 6684

Surface: 6678



DBE-0002
Premier Elite FMK Flush Mount Backbox

Texecom Dry-lining Back Box For Flush Mount Premier Elite Keypads

Our code:
6689

CAA-0026
Premier Elite 24 Zone Polymer LS1



- 8 Zones Expandable To 24
- 2 Areas
- 25 User Codes
- 500 Event Log Time & Date Stamped
- EN rated energy efficient switch mode power supply
- Plug-on Digimodems
- Multiple communication options; PSTN/GSM/GPRS/IP
- Remote diagnostics and upload/download via Wintex software
- PD6662:2017 Grade 2 Class II

Our code:

6639

CAA-0004
Premier Elite 24 Zone Metal LS1



- 8 Zones Expandable To 24
- 2 Areas
- 25 User Codes
- 500 Event Log Time & Date Stamped
- EN rated energy efficient switch mode power supply
- Plug-on Digimodems
- Multiple communication options; PSTN/GSM/GPRS/SMS
- Remote diagnostics and upload/download via Wintex software
- EN50131-1, EN50131-3 Grade 3 Class II

Our code:

6640

CAB-0001
Premier Elite 48 Zone Metal



- 8 Zones Expandable To 48
- 4 Areas
- 50 User Codes
- 500 Event Log Time & Date Stamped
- EN rated energy efficient switch mode power supply
- Plug-on Digimodems
- Multiple communication options; PSTN/GSM/GPRS/SMS
- Remote diagnostics and upload/download via Wintex software
- EN50131-1, EN50131-3 Grade 3 Class II

Our code:

6642

GEW-0001
Premier Elite 64-W LS1



- Facilitates more devices per system to support increased security, safety and automation device requirements
- 32 on-board wireless zones; expandable to 64 wireless zones
- Contains Texecom Connect 'ready' Premier Elite firmware
- EN50131-1, EN50131-3, EN50131-5-3
- PD6662: 2017 Grade 2 Class II

Our code:

6795

CAC-0001
Premier Elite 88 Zone Metal LS1



- 8 Zones Expandable To 88
- 8 Areas
- 100 User Codes
- 1000 Event Log Time & Date Stamped
- EN rated energy efficient switch mode power supply
- Plug-on Digimodems
- Multiple communication options; PSTN/GSM/GPRS/SMS
- Remote diagnostics and upload/download via Wintex software
- EN50131-1, EN50131-3 Grade 3 Class II

Our code:

6644

CAD-0001
Premier Elite 168 Zone Metal LS1



- 8 Zones Expandable To 168
- 16 Areas
- 200 User Codes
- 2000 Event Log Time & Date Stamped
- EN rated energy efficient switch mode power supply
- Plug-on Digimodems
- Multiple communication options; PSTN/GSM/GPRS/SMS
- Remote diagnostics and upload/download via Wintex software
- EN50131-1, EN50131-3 Grade 3 Class II

Our code:

6646

CAE-0001
Premier Elite 640 Zone Metal LS1



- Expandable To 640 Zones
- 64 Areas
- 500 User Codes
- 5000 Event Log Time & Date Stamped
- Plug-on Digimodems
- Multiple communication options; PSTN/GSM/GPRS/SMS
- Remote diagnostics and upload/download via Wintex software

Our code:

6647

Wall Mount



AKB-0001 - P15
Capture 15m PIR
Grade 2 wired wall mount

- 15m / 90 ° volumetric coverage
- Dual element pyro
- Optional PetWise mode
- EN50131-2-2 Grade 2
- Possibility to customise your Capture PIRs with your logo

Our code:
6925



AKC-0001 - Q20
Capture 20m Quad PIR
Grade 2 wired wall mount

- 20m / 90 ° volumetric coverage
- Quad element pyro
- Optional PetWise mode
- EN50131-2-2 Grade 2
- Possibility to customise your Capture PIRs with your logo

Our code:
6926



AKD-0001 - D20
Capture 20m Dual Tech PIR
Grade 2 wired wall mount

- 20m / 85° coverage
- Quad pyro + K-band microwave
- Dual tech/PetWise/CloakWise modes
- EN50131-2-4 Grade 2
- Possibility to customise your Capture PIRs with your logo

Our code:
6927



AKE-0001 - A20
Capture 20m Anti-Masking Dual Tech PIR Grade 3 wired wall mount

- 20m / 85 ° volumetric coverage
- Quad element pyro & K-band microwave
- Low Sensitivity/CloakWise/Dual Tech
- EN50131-2-4 Grade 3
- Possibility to customise your Capture PIRs with your logo

Our code:
6928

Ceiling Mount



AKF-0001 - CQ
Capture Quad PIR
Grade 2 wired ceiling mount

- 9.3m / 360 ° coverage
- Quad element pyro
- Optional Low sensitivity mode
- N50131-2-2 Grade 2
- Possibility to customise your Capture PIRs with your logo

Our code:
6929



AKG-0001 - CD
Capture Quad Dual Tech PIR
Grade 2 wired ceiling mount

- 9.3m / 360° coverage
- Quad element pyro
- Low sensitivity/Dual tech/CloakWise
- EN50131-2-4 Grade 2
- Possibility to customise your Capture PIRs with your logo

Our code:
6930



AKH-0001
Capture Anti-Masking PIR

- Possibility to customise your Capture PIRs with your logo

Our code:
6931

Outdoor Twin-dual PIR



AFQ-0002 - White
Premier External Twin-dual PIR
outdoor motion detector

- Dual, Non Over-Lapping, Digital PIR
- Adjustable optics and adjustable sensitivity
- Digital temperature compensation
- IP65 sealed enclosure
- Day/night mode and high white light immunity
- Quick and simple to install

Our code:
6631



AFQ-0001 - Black
Premier External Twin-dual PIR
outdoor motion detector

- Dual, Non Over-Lapping, Digital PIR
- Adjustable optics and adjustable sensitivity
- Digital temperature compensation
- IP65 sealed enclosure
- Day/night mode and high white light immunity
- Quick and simple to install

Our code:
6630



AEA-0001
Veritas Impaq E Vibration Shock Sensor

- Detection Type: Vibration
- Adjustable Sensitivity
- Engineer Setup
- Detection LED
- LED Disable
- Comfort LED
- PD6662:2010 Grade 2 Class II

Our code:

6606



AEK-0001 - White
Impaq SC
Wired Shock and Contact

- VIBER™ Accelerometer Technology
- Shock and Magnetic Contact
- Digital Signal Processing
- 5 Selectable Digital Sensitivity Settings
- Intuitive LED Assisted Setup Procedure
- Built-in EOL Resistors
- EN50131-2-8 Grade 2
- EN50131-2-6 Grade 2
- PD6662:2017 Grade 2
- Environmental Class II

Our code:

6918



AEK-0003 - Grey
Impaq SC
Wired Shock and Contact

- VIBER™ Accelerometer Technology
- Shock and Magnetic Contact
- Digital Signal Processing
- 5 Selectable Digital Sensitivity Settings
- Intuitive LED Assisted Setup Procedure
- Built-in EOL Resistors
- EN50131-2-8 Grade 2
- EN50131-2-6 Grade 2
- PD6662:2017 Grade 2
- Environmental Class II

Our code:

6920



AEK-0002 - Brown
Impaq SC
Wired Shock and Contact

- VIBER™ Accelerometer Technology
- Shock and Magnetic Contact
- Digital Signal Processing
- 5 Selectable Digital Sensitivity Settings
- Intuitive LED Assisted Setup Procedure
- Built-in EOL Resistors
- EN50131-2-8 Grade 2
- EN50131-2-6 Grade 2
- PD6662:2017 Grade 2
- Environmental Class II

Our code:

6919



AEC-0001
Premier Impaq Glass Break Detector AE

- Detection Type: Accoustic
- Suited for plate, tempered, laminated and wired glass types
- Adjustable Sensitivity
- Engineer Setup
- Detection LED
- LED Disable
- Comfort LED
- Microprocessor Technology
- First To Alarm & Latch Input
- Digital Signal Processing
- Advanced Signal Processing Algorithms

Our code:

6608



E50
Surface Contact 4 Core Potted

E50 provides protection against tampering and environmental factors through the use of fully sealed internals – the switch itself is encased in a hard wearing resin. Rear cable entry allows it to be installed without visible external conduit.

Our code:

6900



E70W - White
Mini Surface Contact 4 Core

- Single Reed
- Self-adhesive pads to fit on door/window frame without screws
- Environmental Class 3
- Operation Gap: 15mm Approx
- Dimensions: 38mm x 9mm x 16mm,
- Terminals: 4-Core
- Cable Length: 1m

Our code:

6901



E70B - Brown
Mini Surface Contact 4 Core

- Single Reed
- Self-adhesive pads to fit on door/window frame without screws
- Environmental Class 3
- Operation Gap: 15mm Approx
- Dimensions: 38mm x 9mm x 16mm,
- Terminals: 4-Core
- Cable Length: 1m

Our code:

6902



D70W - White
Surface Junction Reed
6 Screw Type

A large surface contact complete with a leaf tamper switch. Of the included 6 wiring screws, 2 are used for the switch, 2 for the leaf tamper and 2 are left spare for any additional wiring. Tamper switch detects removal of the contact lid meeting the requirements of Security Grade 2.

Our code:

6903



D70B - Brown
Surface Junction Reed
6 Screw Type

A large surface contact complete with a leaf tamper switch. Of the included 6 wiring screws, 2 are used for the switch, 2 for the leaf tamper and 2 are left spare for any additional wiring. Tamper switch detects removal of the contact lid meeting the requirements of Security Grade 2.

Our code:

6904



J40W - White
Alarm Junction Box 7 Screw

- Grade: 2
- Environmental Class 2
- Material : HIPS
- Terminals : 5 + 2
- Temp Range: -40C to 50C
- Tamper: Leaf
- Size: 78x24x22mm
- Access: 2 End Knock-outs 2 Back Holes

Our code:

6906



J40B - Brown
Alarm Junction Box 7 Screw

- Grade: 2
- Environmental Class 2
- Material : HIPS
- Terminals : 5 + 2
- Temp Range: -40C to 50C
- Tamper: Leaf
- Size: 78x24x22mm
- Access: 2 End Knock-outs 2 Back Holes

Our code:

6907



J80W - White
Alarm Junction Box 10 Screw

- Grade: 3
- Environmental Class 2
- Material : HIPS
- Terminals : 8 + 2
- Temp Range: -40C to 50C
- Tamper: Leaf
- Size: 70x56x20mm
- Access: 8 End Knock-outs 4 Back Holes

Our code:

6908



J80B - Brown
Alarm Junction Box 10 Screw

- Grade: 3
- Environmental Class 2
- Material : HIPS
- Terminals : 8 + 2
- Temp Range: -40C to 50C
- Tamper: Leaf
- Size: 70x56x20mm
- Access: 8 End Knock-outs 4 Back Holes

Our code:

6910



J24
Alarm Junction Box 24 T Block

- Grade: 3
- Environmental Class 2
- Material: HIPS
- Terminals: 24 choc block (2 tamper)
- Temp Range: -40C to 50C
- Tamper: TACT
- Switch Size: 125x100x48mm
- Access: 4 End Knock-outs 6 Back Holes

Our code:

6911



E90A
Metal Surface Contact 4 Core

Provides a sturdy, aluminium housed contact with a small form factor. This Grade 2 contact is ideal for fitting on Patio doors. The internals are sealed for environmental/tamper protection, with a 1 metre length of 4 core fly lead Provided for wiring. Comes complete with fitting screws.

Our code:

6905



H10A
Heavy Duty Contact 4 Wire ALU

- Grade: 2
- Aluminium Angle Contact
- Single Reed
- Env Class III, 4-Wire, Armoured Sleeve 18" (457mm)
- Dimensions: 80mm x 25mm x 27mm
- Operating Gap: 50mm
- Material: Anodised Aluminium

Our code:

6913



F10A
Roller Shutter & H/Duty
Contact 4 Wire

- Grade: 2, Model: F10A, Roller Shutter
- Single Reed
- Cable protected by 18" (457mm) armoured sleeving
- Dimensions: 150mm x40mm x 15mm
- Operating Gap: 50mm
- IP67
- Material: Aluminium

Our code:

6912

Heat Detectors



AGB-0001 - OH Exodus OH/4W Heat Detector

- 12V/4-wire Operation With Alarm Relay: 4W
- Conventional Fire 10V-30V Operation
- Suitable for fastest detection for wide range of fires (Smouldering fires and fast flaming fires)
- Unsuitable for environments with airborne contamination
- Microprocessor Technology
- Digital Technology Detection Algorithm
- Digital Drift Compensation
- Optical & Thermal Detection

Our code:

6632



AGB-0002 - RR Exodus RR/4W Heat Detector

It detects rapid temperature increases or temperatures above 58°C.

- 12V/4-wire Operation With Alarm Relay: 4W
- Conventional Fire 10V-30V Operation
- Suitable for fast fire detection where normal temperatures do not exceed 38°C Unsuitable for environments where the temperature may change rapidly
- Microprocessor Technology
- Digital Technology Detection Algorithm

Our code:

6633

Panic Button



KP5 Wired Panic Button - 2 Button

- Silent operation
- 'ACPO 10 Point Plan' compliant
- EN50131-1, EN50131-5-3
- PD6662:2017 Grade 2 Class II
- Compatible with Premier Elite control panels*
- Manufactured in partnership with Elmdene

Our code:

6940

Wall Mount



GDA-0001 - P15W
Capture 15m PIR
Grade 2 wireless wall mount

- 15m / 90° volumetric coverage
- Dual element pyro
- Optional PetWise mode
- EN50131-2-2 Grade 2
- Possibility to customise your Capture PIRs with your logo

Our code:

6932



GDB-0001 - Q20-W
Capture 20m Quad PIR
Grade 2 wireless wall mount

- 20m / 90° volumetric coverage
- Quad element pyro
- Optional PetWise mode
- EN50131-2-2 Grade 2
- Possibility to customise your Capture PIRs with your logo

Our code:

6954



GDC-0001 - D20W
Capture 20m Dual Tech PIR
Grade 2 wireless wall mount

- 20m / 85° coverage
- Quad pyro + K-band microwave
- Dual tech/PetWise/CloakWise modes
- EN50131-2-4 Grade 2
- Possibility to customise your Capture PIRs with your logo

Our code:

6933

Ceiling Mount



GDD-0001 - CQW
Capture Quad PIR
Grade 2 wireless ceiling mount

- 9.3m/360° coverage
- Quad element pyro
- Optional low sensitivity mode
- EN50131-2-2 Grade 2
- Possibility to customise your Capture PIRs with your logo

Our code:

6934



GDE-0001 - CDW
Capture Quad Dual Tech PIR
Grade 2 wireless ceiling mount

- 9.3m / 360° coverage
- Quad element pyro & K-band microwave detection
- Low sensitivity / Dual tech / CloakWise modes
- EN50131-2-4 Grade 2
- Possibility to customise your Capture PIRs with your logo

Our code:

6935

Outdoor Twin-dual PIR



GBW-0001 - Black
Premier External Twin-dual PIR
868MHz

- 12m volumetric range, adjustable to 8, 5 & 2 metres
- Ricochet mesh technology
- 90° viewing angle, rotatable through 180°
- Non-overlapping twin mirrored PIR optics
- Day / night mode
- Powered by 2 x AA batteries (supplied) Up to 4 years battery life

Our code:

6773



GBW-0001 - White
Premier External Twin-dual PIR
868MHz

- 12m volumetric range, adjustable to 8, 5 & 2 metres
- Ricochet mesh technology
- 90° viewing angle, rotatable through 180°
- Non-overlapping twin mirrored PIR optics
- Day / night mode
- Powered by 2 x AA batteries (supplied) Up to 4 years battery life

Our code:

6774



GJA-0001 - White
Impaq SC-W Wireless
Shock and Contact Sensor

- VIBER™ Accelerometer Technology
- Shock and Magnetic Contact
- Wireless Signalling with Ricochet Mesh Technology
- Digital Signal Processing
- 5 Selectable Digital Sensitivity Settings
- Intuitive LED Assisted Setup Procedure
- 3 Year Typical Battery Life
- Roller Shutter Input for 'Partly Open' Protection
- EN50131-2-8 Grade 2
- Environmental Class II

Our code:

6921



GJA-0005 - Grey
Impaq SC-W Wireless
Shock and Contact Sensor

- VIBER™ Accelerometer Technology
- Shock and Magnetic Contact
- Wireless Signalling with Ricochet Mesh Technology
- Digital Signal Processing
- 5 Selectable Digital Sensitivity Settings
- Intuitive LED Assisted Setup Procedure
- 3 Year Typical Battery Life
- Roller Shutter Input for 'Partly Open' Protection
- EN50131-2-8 Grade 2
- Environmental Class II

Our code:

6922



GJA-0004 - Brown
Impaq SC-W Wireless
Shock and Contact Sensor

- VIBER™ Accelerometer Technology
- Shock and Magnetic Contact
- Wireless Signalling with Ricochet Mesh Technology
- Digital Signal Processing
- 5 Selectable Digital Sensitivity Settings
- Intuitive LED Assisted Setup Procedure
- 3 Year Typical Battery Life
- Roller Shutter Input for 'Partly Open' Protection
- EN50131-2-8 Grade 2
- Environmental Class II

Our code:

6923



GHA-0001 - White
Premier Elite Micro door
Contact-W

- Ricochet Mesh Technology
- Compatible with Premier Elite
- Control Panels, Premier control panels & Ricochet Expansion packs.
- Cost Effective
- 4 Year Battery Life (Typical)
- LED Assisted setup procedure
- EN50131-2-6 Grade 2
- Complete with Adhesive or Screw Fixing Options
- Dimensions: H 57mm x W 27.5mm x D 11.5mm.

Our code:

6787



GHA-0002 - Grey
Premier Elite Micro door
Contact-W

- Ricochet Mesh Technology
- Compatible with Premier Elite
- Control Panels, Premier control panels & Ricochet Expansion packs.
- Cost Effective
- 4 Year Battery Life (Typical)
- LED Assisted setup procedure
- EN50131-2-6 Grade 2
- Complete with Adhesive or Screw Fixing Options
- Dimensions: H 57mm x W 27.5mm x D 11.5mm.

Our code:

6788



GHA-0003 - Brown
Premier Elite Micro door
Contact-W

- Ricochet Mesh Technology
- Compatible with Premier Elite
- Control Panels, Premier control panels & Ricochet Expansion packs.
- Cost Effective
- 4 Year Battery Life (Typical)
- LED Assisted setup procedure
- EN50131-2-6 Grade 2
- Complete with Adhesive or Screw Fixing Options
- Dimensions: H 57mm x W 27.5mm x D 11.5mm.

Our code:

6789



GHC-0001 - White
Ricochet Micro Shock-W
Shock Sensor

- Smallest shock sensor on the market
- Superior accelerometer technology
- LED assisted set-up procedure
- Complies to the latest EN50131-2-8 Grade 2 shock sensor standard
- 3 year typical battery life
- Ricochet Mesh technology
- Mounting surfaces - uPVC, wood, concrete and aluminium
- Compatible with Premier Elite and Premier panels
- 57mm x 27.5mm x 8.2mm

Our code:

6790



GHC-0002 - Grey
Ricochet Micro Shock-W
Shock Sensor

- Smallest shock sensor on the market
- Superior accelerometer technology
- LED assisted set-up procedure
- Complies to the latest EN50131-2-8 Grade 2 shock sensor standard
- 3 year typical battery life
- Ricochet Mesh technology
- Mounting surfaces - uPVC, wood, concrete and aluminium
- Compatible with Premier Elite and Premier panels
- 57mm x 27.5mm x 8.2mm

Our code:

6791



GHC-0003 - Brown
Ricochet Micro Shock-W
Shock Sensor

- Smallest shock sensor on the market
- Superior accelerometer technology
- LED assisted set-up procedure
- Complies to the latest EN50131-2-8 Grade 2 shock sensor standard
- 3 year typical battery life
- Ricochet Mesh technology
- Mounting surfaces - uPVC, wood, concrete and aluminium
- Compatible with Premier Elite and Premier panels
- 57mm x 27.5mm x 8.2mm

Our code:

6792



GCC-0001
Premier Elite SmartKey
Wireless Iconic Keyfob

- Remote arm, part arm and disarm
- Integral RFID proximity tag for use with compatible prox readers
- Alarm system status display
- Programmable two button panic alarm
- Remote control of up to 3 programmable outputs. Typical applications include garage door control, external lighting control and automatic gate control
- Replaceable lithium CR2 battery offers 2 to 3 year typical battery life
- PD6662: 2017, EN50131-1, EN50131-3, EN50131-5-3 Grade 2 Class II

Our code:

6802



GBG-0001 - PA DP-W
Premier Elite Wireless Double
Push Panic Button

- Silent operation
- Up to 4-year battery life
- 'ACPO 10 Point Plan' compliant
- EN50131-1, EN50131-5-3
- PD6662:2017 Grade 2 Class II
- Compatible with Premier Elite control panels*
- Manufactured in partnership with Elmdene

Our code:

6778

Kits

KIT-0079 (868 MHz) Premier Elite Ricochet External Kit



The Ricochet External Kit features an 8-device wireless expander and relay interface card for connecting to any security system, plus two Premier External TD-W external detectors.

- 1 x Premier Elite IXP-W
- 1 x Premier Elite 8XP-W
- 2 x Premier External TD-W

Our code:

6817

KIT-0080 (868 MHz) Premier Elite Ricochet Smoke Kit



The Ricochet Smoke Kit features an 8-device wireless expander and relay interface card for connecting to any security system, plus two Premier Elite OH-W smoke detectors.

- 1 x Premier Elite IXP-W
- 1 x Premier Elite 8XP-W
- 2 x Premier Elite OH-W

Our code:

6818

KIT-0081 (868 MHz) Premier Elite Ricochet Safety Kit



The Ricochet Safety Kit features an 8-device wireless expander and relay interface card for connecting to any security system, plus one Premier Elite OH-W smoke detector and one Premier Elite CO-W carbon monoxide sensor.

- 1 x Premier Elite IXP-W
- 1 x Premier Elite 8XP-W
- 1 x Premier Elite OH-W
- 1 x Premier Elite CO-W

Our code:

6819

GEC-0002 (868 MHz) Ricochet Expansion Pack (IXP-W)



8-zone interface card that converts wireless devices into relay-driven wired outputs.

- 1 x Premier Elite 8XP-W
- 1 x Premier Elite IXP-W
- Frequency Band 868.0MHz - 868.6MHz

Our code:

6803

Detector & Sensor

GBN-0001 - OH-W Wireless Smoke & Heat Detector



- Compatible with Premier Elite control panels V2.11 and above
- Optical and heat fire sensing
- Ricochet mesh technology
- 85dB(A) built-in sounder
- Powered by 3 x AAA batteries (included)
- Long battery life
- EN14604, EN50131-5-3, EN50131-1, PD6662:2010, Grade 2 Class II

Our code:

6772

GBY-0001 - CO-W Premier Elite Wireless Carbon Monoxide Sensor



- Continually monitoring CO sensor
- Compatible with Premier Elite control panels (V3.02 firmware or above)
- Ricochet mesh technology
- 10 year sensor lifespan
- 4 year typical battery life (2 x 1.5V AA Alkaline, included)
- EN50131-1, EN50131-5-3 Grade 2 Class II
- EN50291-1 Approved

Our code:

6771

Smartplug

GFA-0001 - UK Connect SmartPlug 868MHz



Control any mains-powered device Remotely with the Texecom Connect SmartPlug.

This Ricochet® enabled wireless plug sits between a wall socket and the power plug of a device, and is controlled via the Texecom Connect App.

Our code:

6783



WDC-0001 - X-BE
Odyssey X Grade 2 Sounder
Backplate with Integral Backlight

- 109dB (A) piezo sounder
- Wall & cover tamper
- Patented engineer hold-off mode
- Alternating white LED indication
- EN50131-4 Grade 2 Class IV

Our code:

6769



WDC-0002 - X-B
Odyssey X Grade 3 Sounder
Backplate with Integral Backlight

- 115dB (A) twin piezo sounder
- Wall & cover tamper
- Patented engineer hold-off mode
- Battery monitoring with fault output
- Alternating white LED indication
- EN50131-4 Grade 3 Class IV

Our code:

6768



GBV-0001 - X-W
Odyssey X Wireless Sounder
Backplate

- 105dB (A) piezo sounder
- Wall & cover tamper
- Selectable comfort LEDs
- Ricochet mesh technology
- 8 x AA lithium batteries included
- EN50131-4, EN50131-5-3 Grade 2 Class IV

Our code:

6749



GBX-0001 - 5Ci-W (868MHz)
Premier Elite Internal
wireless sounder

- 105dB(A) Piezo Sounder
- High Brightness LED Strobe
- Selectable Comfort LEDs
- Wall and Lid Tamper
- 2 to 5 Year Battery Life
- Compatible with Premier Elite control panels
- Powered by 8 x AA Lithium Batteries (included)
- PD6662:2010, EN50131-4, EN50131-5-3 Grade 2 Class

Our code:

6804

Odyssey X covers

Custom graphic inserts for professional branding, A choice of 6 electronic backplate modules, Illuminated X1 cover options, Wired, wireless & dummy versions, White comfort LEDs, A host of installer-friendly features. Designed to comply with EN50131-4.



Lens colour options:

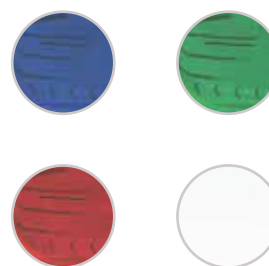

Our code: 6758

Part No: WDB-0001 White/Blue

Our code: 6759

Part No: WDB-0002 White/Red

Our code: 6761

Part No: WDB-0004 Black/Blue

Our code: 6762

Part No: WDB-0005 Black/Blue

Our code: 6763

Part No: WDB-0006 Black/White

Our code: 6764

Part No: WDB-0007 Black/Green

Our code: 6765

Part No: WDB-0008 White/Green



CEL-0001
Connect SmartCom (Wifi & Ethernet)

The Texecom SmartCom is an Ethernet and WiFi communicator that facilitates the Texecom Connect experience by connecting any Premier Elite control panel to a local area network.

Texecom Connect integrates with Texecom's flagship security systems, the Premier Elite Series, to allow you to take direct control of your home and your security. Control the operation of your security system, receive notifications of system events and monitor cameras or activity from anywhere in the world.

Our code:
6656



CEL-0007
Connect SmartCom Lan/Wifi & 4G

Texecom's new SmartCom 4G adds new connectivity options for Premier Elite systems improving connection reliability.

Providing access to Texecom Cloud and Texecom Connect (V2) services via single path (4G) or dual path (4G plus ethernet or WiFi), the SmartCom 4G is always on, always ready, and always available.

- Single path 4G can be used without any additional network Infrastructure
- Perfect for new commercial installations where IT networks are not yet operational
- Completely wire-free installations are perfect for remote sites or outbuildings, or where there are no local internet options available
- Dual path 4G plus ethernet or Wifi provides best of both worlds
- 4G backup provides continuity in the event of power failure, local network availability or ISP issues

Our code:
6936



CEC-0001 - CTR21
Premier Elite Com2400

- Plug-on multi-protocol digital communicator
- Premier Elite Series Compatible
- Modem Speed (Baud) 2400
- SMS Text Facility
- ATS Class 2

Our code:
6658



CGE-0002
Premier Elite Speech Module & Com2400 Kit

- Plug-on PCB + Com2400
- Plug-on PCB features:
 - Premier Elite Series Compatible
 - Modem Speed (Baud) 300
 - Full upload/download
 - System programming diagnostics
 - ATS Class 2

Our code:
6663



Alarm Companies:
 Manage, configure
 and control your
 alarm system
 portfolio



Texecom Cloud Packages
 4G optional backup
 from €3.50 p/month
 per site

Wired Expanders



CCD-0001 - 8XE Premier 8 Zone Expander

- Plug-on zone expander for use with Premier Elite 24 control panel only.
- Provides 8 additional zones
- 2 programmable outputs
- Grade 3

Our code:
6653



CCB-0001 - 8XP Premier Elite Expander

- Premier Elite Series Compatible
- 8 Additional Outputs
- 1 Auxiliary Input
- Speaker Driver
- PD6662:2017 Grade 3 Class II

Our code:
6649



CCK-0001 - RM8 Premier Elite Relay Module

- For use with the Premier Elite Series of control panels.
- Premier Series Compatible
- 8 Relay Outputs
- Remote Wired
- Plug-On - Premier Elite Series Only (except Premier Elite 24 and Premier Elite 48-W)
- PD6662:2010 Grade 3 Class II

Our code:
6652



CCJ-0001 - PSU200XP Premier Elite Expander & PSU

- Efficiency rating of over 80%
- Savings of more than 40% in running costs compared with Linear power supplies
- Full monitoring & Diagnostics with Premier Elite Control Panels
- Includes Premier Elite 8XP expander
- Space for two independently monitored 7Ah batteries or 1 x 18Ah battery
- PD6662:2010 Grade 3 Class II

Our code:
6651

Wireless Expanders



GCD-0001 - 8XP-W Premier 8 Zone Expander

- Compatible with Texecom Premier Elite Control Panels Wireless
- Monitor Software Diagnostics
- Engineers Keypad Connectivity
- Suitable for Commercial Applications,
- PD6662:2010 Grade 2 Class II

Our code:
6801



GCA-0001 - 32XP-W Premier Elite 32 Zone Expander

- Compatible with Texecom Premier Elite Control Panels, Wireless
- Monitor Software Diagnostics,
- Engineers Keypad Connectivity
- Suitable for Commercial Applications
- PD6662:2010 Grade 2 Class II

Our code:
6800

Alarm Cables

OUR CODE



7551

**4 Core Alarm Cable
100mtr White**

OUR CODE



7552

**6 Core Alarm Cable
100mtr White**



7553

**8 Core Alarm Cable
100mtr White**

Peripherals



**JAA-0001
Premier Elite PC-Com**

Serial interface connector for connection between control panel and PC, enabling local upload/download.

Our code:

6806



**JAC-0001
Premier Elite USB-Com**

USB interface connector for connection between control panel and PC, enabling local upload/download.

Our code:

6807



**CDH-0001
Premier Elite Firmware**

The Premier Elite Flasher Interface can be used to update the Premier Elite Control Panels firmware, allowing additional features and functions to be added to existing systems.

Our code:

6655



**CGA-0001
Speech Dialler**

- 2 Programmable Outputs
- 4 Trigger Inputs
- Listen-In Mode 4 Voice Messages
- Talkback Mode
- 8 Contact Numbers
- 4 Text Messages
- Remote Access Via Touch-Tone Phone, Call Abort
- Context Sensitive Help
- Passcode Protected

Our code:

6673



**CGC-0001
Speech & Text Dialler**

- 4 trigger inputs / voice messages each
- up to 32 secs long
- 8 contact numbers
- 4 text messages
- Call acknowledgement
- 2 programmable outputs
- Listen-in mode
- Talkback mode
- Memo feature
- Remote access/control/programming
- Context sensitive help

Our code:

6674



**CDB-0001
Premier Elite proximity key tags**

Slim and un-obtrusive proxy keytag allows simple setting and un-setting of Texecom Premier alarm panels, when used in conjunction with the Texecom Premier LCD and LCDLP or any of the Texecom Premier Elite remote keypads.

Our code:

6654



**BBC-0001
Premier Elite i-Prox & External Box**

The iProx provides support for Texecom Proximity tags. It can be used as a single door access controller. Premier Elite Series Compatibility

The External Box: Designed for use with the Premier Elite iProx and Texecom Proximity Tags, For use with Premier Elite iProx and Texecom Proximity Tags, Allows the user to disarm the alarm system externally

Our code:

6636

FORMRACK®

Wall mounted & Free Standing Cabinets



Formrack Data Cabinets

19" WALL MOUNTED CABINETS | 19" FREE STANDING CABINETS | SERVER
CABINETS | LITE SERIES | ACCESSORIES |

Soho Range



FORM SH-4U 4U 400 SOHO Cabinet

- Removable rear panel.
- 4mm tempered glass front door with a lock.
- Size height: 4U
- Colour: Grey
- Used for installation of small systems
- Standard depth size: 400mm
- Impact-resistant paint

Our code:

44001



FORM SH-7U 7U 400 SOHO Cabinet

- Removable rear panel.
- 4mm tempered glass front door with a lock.
- Size height: 7U
- Colour: Grey
- Used for installation of small systems
- Standard depth size; 400 mm
- Impact-resistant paint

Our code:

44002

Alfaline Range

- The front and side covers are openable, lockable and easily removable.
- The rear cover is made by high strength 1,5 mm DKP sheet that provides high strength with holes for wall mounting.
- Ventilation is provided by cooling units with 1 or 2 fans.
- There are three options of depth; 450 mm, 560 mm and 600 mm. Five options of height; 7U, 9U, 12U, 16U and 20U.
- There are two mounting profiles in 450 mm depth cabinets and four mounting profiles in 560 mm and 600 mm depth cabinets.
- Cabinets have cable entries from 3 different points on the bottom frame, top frame and rear cover.
- If required, it can be used as a floor type by attaching a fixed foot or castor.
- Painted by impact-resistant, high strength, electrostatic Ral 7035 texture grey color.
- All test procedures have been carried out and has ROSH, CE, EN 61587-1 standards.



Our code

| | | | |
|--------------|------------------|---|--|
| 44004 | FORM ALFA-7U450 | 7U 450 Alfaline Wall Mounting Cabinet | |
| 44005 | FORM ALFA-9U450 | 9U 450 Alfaline Wall Mounting Cabinet | |
| 44006 | FORM ALFA-12U450 | 12U 450 Alfaline Wall Mounting Cabinet | |
| 44007 | FORM ALFA-16U450 | 16U 450 Alfaline Wall Mounting Cabinet | |
| 44008 | FORM ALFA-7U560 | 7U 560 Alfaline Wall Mounting Cabinet | |
| 44009 | FORM ALFA-9U560 | 9U 560 Alfaline Wall Mounting Cabinet | |
| 44010 | FORM ALFA-12U560 | 12U 560 Alfaline Wall Mounting Cabinet | |

Slimrack



FORM SLM-5U 19" Slimrack Wall mounting cabinet

- Used in offices and where small systems are involved.
- It provides 5U usage area, 3U front and 2U rear.
- Can be mounted to the wall or roof in accordance to usage.
- It has 140 mm thickness from the wall.

Our code:

44003

Interline Range

- The front and rear covers are openable, lockable and easily removable.
- The rear and side covers are made by DKP sheet and the front side is made by 4 mm thick, impact-resistant, tempered and smoked-colored glass which is supported by metal frames.
- The main frame is 1 mm, mounting profiles are 1,5 mm.
- Ventilation is provided by cooling units with 2 or 4 fans.
- In 600x600 frame structure, there are 12U, 16U, 20U, 26U height options.
- At the bottom part of the cabinets, there is a brushed cable entry.
- It has the option of using wheeled and fixed legs.
- Painted by impact-resistant, high strength, electrostatic black color.



Our code

| | | | |
|--------------|------------------|--------------------------------------|--|
| 44011 | FORM INT-12U6060 | 12U 600x600 Interline Cabinet | |
| 44012 | FORM INT-16U6060 | 16U 600x600 Interline Cabinet | |
| 44013 | FORM INT-20U6060 | 20U 600x600 Interline Cabinet | |
| 44014 | FORM INT-26U6060 | 26U 600x600 Interline Cabinet | |

Server Cabinet

- Server cabinets have four side openable, lockable and easily removable covers.
- All covers are made by DKP sheet and the front and rear covers have a vertically double open perforated structure.
- The main frame is 1,5 mm, side and rear covers are 1,2 mm steel sheet.
- The frame and corner profiles have nested structure and this structure provides high strength.
- Ventilation is provided by cooling units with 2,4 or 6 fans.
- There are 600x1000 and 800x1000 dimensions and 26U, 32U, 36U and 42U height options.
- There are four 19" mounting profiles with 2mm sheet thickness and these profiles can move deep within the cabinet.
- Mounting profiles have U markings that facilitate the mounting process.
- At the bottom and top parts, there is a dust-protected brushed cable entry.
- It has the option of using wheeled and fixed legs.
- The cabinet has a balance foot against tilting.
- Impact-resistant, high strength, electrostatic black color.



Our code

| | | | |
|--------------|------------------|--|--|
| 44015 | FORM SC-26U60100 | 19" Server Cabinet 26U 600x1000 | |
| 44016 | FORM SC-32U60100 | 19" Server Cabinet 32U 600x1000 | |
| 44017 | FORM SC-42U60100 | 19" Server Cabinet 42U 600x1000 | |
| 44018 | FORM SC-36U80100 | 19" Server Cabinet 36U 800x1000 | |
| 44019 | FORM SC-42U80100 | 19" Server Cabinet 42U 800x1000 | |

Cooling Units

- It is used to absorb the heat produced by the devices and to throw it out of the cabinet. One fan provides 2.3 cubic meters of air circulation per minute.
- It can be used in wall mounted cabinets. (560 Depth)
- All fan groups can be used with digital thermostat controlled.



Our code

| | | | |
|--------------|--------|---------------------------------------|--|
| 44020 | F022F2 | Cooling unit with 2 fan+on/off switch | |
| 44021 | F022F4 | Cooling unit with 4 fan+on/off switch | |

Power Distribution Units

- Circuit breaker protection.
- Complete with power cord.
- Easy to install.



UK/IRL sockets

Our code

| | | | |
|--------------|--------------|---|--|
| 44022 | F082PR6SAUK | 19" 6 way PDU with circuit breaker (UK Type) | |
| 44023 | F082PR9SAUK | 19" 9 way PDU with circuit breaker (UK Type) | |
| 44024 | F082PR12SAUK | 19" 12 way PDU with circuit breaker (UK Type) | |

Shelves

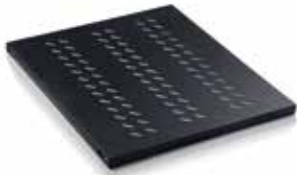

F2166SR
19" Fixed Shelves

- Loading capacity: 50 Kg.
- Material: sheet steel.
- Color: black
- Easy to install.

Our code:

44025



F101RA2U
19" 2U Rack Mount Shelf

- Loading capacity: 20Kg.
- d=350mm
- Material: sheet steel.
- Color: black
- Non-ventilated
- Easy to install

Our code:

44026

Cable Management Panels



Our code

| | | | |
|--------------|-----------|--|--|
| 44027 | F0565O1U | 1U 19" Cable Management Panel | |
| 44028 | F0565O2U | 2U 19" Cable Management Panel | |
| 44029 | F0565FO1U | 1U 19" Cable Management Panel with Brush | |
| 44030 | F0565KO1U | 1U 19" Cable Management Panel with Cover | |
| 44031 | F0565OT | 1U Cable Management Ring | |
| 44032 | F0565OT2 | 2U Cable Management Ring | |



Accessories

CABLES & CONNECTORS | WIRELESS TRANSMISSION | NETWORK ACCESSORIES
| A/V EXTENDERS | BALUNS & PSU | CCTV ACCESSORIES | AUDIO FOR CCTV

ACCESSORIES & TOOLS

CABLES & CONNECTORS



CAT6 High Quality Patch Lead - Our codes

| | Grey | Blue | Red | Yellow | White |
|------|------|------|------|--------|-------|
| 0.3m | 8040 | 8041 | 8042 | 8043 | 8048 |
| 0.5m | 8014 | 8032 | 8025 | 8028 | 8044 |
| 1m | 8015 | 8033 | 8024 | 8029 | 8045 |
| 1.5m | 8016 | - | 8039 | 1059 | 8049 |
| 2m | 8017 | 8034 | 8026 | 8030 | 8046 |
| 3m | 8018 | 8035 | 8027 | 8031 | 8047 |
| 5m | 8019 | - | - | - | - |
| 10m | 8020 | - | - | - | - |
| 15m | 8051 | - | - | - | - |
| 20m | 8021 | - | - | - | - |
| 25m | 8022 | - | - | - | - |
| 30m | 8023 | - | - | - | - |

CAT6A High Quality Patch Lead - Our codes

| | Grey |
|------|------|
| 0.3m | - |
| 0.5m | 5670 |
| 1m | 5671 |
| 1.5m | 5672 |
| 2m | 5673 |
| 3m | 5674 |
| 5m | 5675 |
| 10m | 5676 |
| 15m | 5730 |
| 20m | - |
| 25m | - |
| 30m | - |



OUR CODE

3393 **100m Indoor U/UTP Indoor CAT6 - Grey Copper**



3394 **100m Indoor U/UTP Outdoor CAT6 - Black Copper**

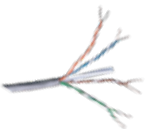

5653 **305m Connectix UTP Indoor CAT5e PVC Cable - Grey**



8502 **BNC Crimping Tool (Universal)**



3639 **Philex CAT5 RJ45 Connector 8p8c - 100pcs**



3647 **RJ45 Coupler**



9900 **• Eazy Crimps CAT5e Connectors - 100pcs**



9908 **• Eazy Crimps CAT5e FTP Connectors - 100pcs**

9903 **• Eazy Crimps CAT6 FTP Connectors - 100pcs**

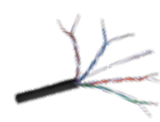

OUR CODE

5656 **305m Connectix Outdoor Bare Copper UTP CAT5e**

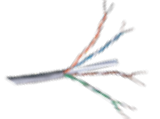

5662 **305m Connectix UTP Indoor CAT6 PVC Cable**

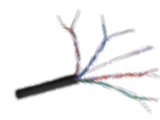

5665 **305m Connectix Outdoor Bare Copper UTP CAT6**



3398 **Mercury RJ-45 Crimp Tool 8p8c**



3712 **Philex CAT6 RJ45 Connector - 100pcs**



9906 **Eazy Crimps Eazy Crimper Tool**



9916 **RJ45 Eazy Mini Crimper**











9904 **• Eazy Crimps CAT5/5e Boots - 100pcs**







9905 **• Eazy Crimps CAT6 Boots - 100pcs**

ACCESSORIES & TOOLS







CABLES & CONNECTORS

| OUR CODE | | OUR CODE | | | |
|--|--------------|--|--|--------------|--|
|  | 3637 3638 | 100m Labgear RG59 Cable 200m Labgear RG59 Cable |  | 3635 3636 | 100m Labgear Black RG59 + 2 Core Power Cable 200m Labgear Black RG59 + 2 Core Power Cable |
|  | 3709 | BNC Crimp On Connector RG59 |  | 3765 | BNC Connector (Twist On) |
|  | 3162 | BNC Coupler Socket to Socket |  | 3245 | BNC T Splitter |
|  | 8502 | BNC Crimping Tool (Universal) |  | 5666 | CAT6 IDC In-Line Connection Box |

WIRELESS TRANSMISSION

| | | | | | |
|---|-------|---|---|--------------|--|
|  | 30804 | GigaWave 2Km Wireless CPE 5g 900Mbps G-CPE-2K |  | 30805 | GigaWave PRO Wireless CPE 48v 4km G-CPE-4K |
|  | 30806 | GigaWave PRO 1200Mbps Wireless CPE G-AP-CPE-8K |  | 5573 5572 | UBNT Nanostation Loco M2 UBNT Nanostation Loco M5 |
|  | 5604 | UBNT Nanostation Loco M5 AC (NS-5ACL) |  | 5641 | UBNT M5 AC NanoStation POE Output NS-5AC |
|  | 5574 | UBNT NanoBeam 5AC Giga NBE-5AC-Gen2 | | | |

NETWORK ACCESSORIES

| | | | | | |
|--|------|---|---|------|--|
|  | 2554 | TP-Link AV600 Nano Power- line TL-PA4010KIT |  | 2561 | TP-Link AV600 TL-PA4010P with AC pass |
|  | 2555 | TP-Link AV600 Powerline Kit Wifi TL-WPA4220KIT |  | 2560 | TP-Link TL-WPA4220v AV600 Extra Unit |
|  | 2627 | TP-Link AV1000 Powerline Kit TL-PA7017KIT |  | 2630 | TP-Link AV1000 Gigabit Powerline ac Wi-Fi Kit |

ACCESSORIES & TOOLS

NETWORK ACCESSORIES









| OUR CODE | | OUR CODE | |
|---|--|--|---|
|  | 12118 Dahua 5 Port 10/100 Switch PFS3005-5ET-L |  | 12120 Dahua 5 Port Gigabit Switch PFS3005-5GT-L |
|  | 12119 Dahua 8 Port 10/100 Switch PFS3008-8ET-L TM-5 GIGA |  | 12121 Dahua 8 Port Gigabit Switch PFS3008-8GT-L |
|  | 12124 Dahua 16 Port Gigabit Network Switch PFS3016-16GT |  | 12125 Dahua 24 Port Gigabit Network Switch - PFS3024-24GT |

A/V EXTENDERS

| | | | |
|---|---|--|---|
|  | 9508 Technomate 4 Way HDMI Splitter Over CAT5/6 with PoE and loopthrough 1080p 50m - Kit | | |
|  | 9528 Technomate 4K 4 Way HDMI Ext over CAT5/6 - Kit | | |
|  | 9506 Technomate HDMI Extender Over CAT IR POE 50m |  | 9514 Technomate TM-55 4K HDR HDMI Over CAT5/6 Extender |
|  | 1021 Triax 4K SKY Q HDMI Extender Kit over CAT5/6 |  | 1025 • Triax 2 Way 4K HDMI Splitter |
| | |  | 1026 • Triax 4 Way 4K HDMI Splitter |
|  | 2055 Triax 2 Way S2 HDMI Splitter |  | 2056 Triax 4 Way S2 HDMI Splitter |
|  | 2064 Triax Point To Point 1080P Kit HDMI Extender |  | 3687 VGA Extender Over CAT5 |
| Standard speed HDMI cable 2027 1m 2028 2m 2029 3m 2030 5m 2031 10m 2032 15m 2033 20m | | High Speed 4K HDMI cable 1074 1.5m 1075 2m 1076 3m 1077 5m 1078 10m 1079 15m 1080 20m | |

ACCESSORIES & TOOLS

A/V EXTENDERS

| OUR CODE | | OUR CODE | | | |
|--|--|--|---|------------------------------|---|
|  | 3564 | 2 Port VGA Splitter |  | 3563 | 4 Port VGA Splitter |
|  | 3596 | VGA Coupler |  | 3558 | VGA to HDMI Converter |
|  | 3521 3522 3523 3524 3525 3526 3527 | VGA to VGA leads 1.5m 3m 5m 10m 15m 20m 50m |  | 6529 6526 6527 6528 | High Quality VGA + 3.5mm Audio 3m 5m 10m 15m |
|  | 3648 | VGA to AV/BNC Converter |  | 4511 | BNC to VGA Converter |

BALUNS & POWER SUPPLIES

| | | | | | |
|--|----------|--|---|---------|---|
|  | HD-BALUN | HD CCTV Video Baluns (pair) up to 8MP |  | 3600 | Video Balun - RJ45 w/ audio/power |
|  | 5735 | Active HD CCTV Balun - Pair |  | 3674 | 4 Way DC Splitter Cable |
|  | 9522 | 12v 5Amp 4 Way Screw Type PSU |  | 12V-30A | 12v 20A 18 Output CCTV Wall Power Supply |
|  | 3597 | Male DC Adapter |  | 12094 | Dahua 12v 5 Output Boxed PSU |
| | 3598 | Female DC Adapter | | 12095 | Dahua 12v 9 Output Boxed PSU |
|  | 3542 | 12V 1A power supply | | | |
| | 3543 | Dahua 12V 2A power supply | | | |
| | 3544 | 12V 5A power supply | | | |

ACCESSORIES & TOOLS

CCTV ACCESSORIES



OUR CODE

13165

Dahua PoE Extender



OUR CODE

13164

Dahua Hi-POE Midspan



12094

Dahua DC12V4A 5-ch CCTV Distributed Power Box



12095

Dahua DC12V5A 9-ch CCTV Distributed Power Box

AUDIO FOR CCTV



3128

• Compact 100V Line Mixer-amplifiers CA30

3129

• Compact 100V Line Mixer-amplifiers CA60



3439

• Adastra UM30 100v Mixer Amp 30w

3440

• Adastra UM30 100v Mixer Amp 60w



3135

RM120 mixer-amp 100V + Bluetooth®



3136

RM240S mixer-amp 100V + Bluetooth®



3337

RM360SB mixer-amp 100V + Bluetooth®



3346

Horn Speaker 9.5in Round 100v 30w



3356

Adastra Active Weatherproof Horn Speaker 25w



3051

3" Outdoor Speaker BP3V Black

3053

4" Outdoor Speaker BP4V Black

3055

5.25" Outdoor Speaker BP5V Black

3057

6.5" Outdoor Speaker BP6V Black



3050

3" Outdoor Speaker BP3V White

3052

4" Outdoor Speaker BP4V White

3054

5.25" Outdoor Speaker BP5V White

3056

6.5" Outdoor Speaker BP6V White

NOTES

KD Electronics LTD

Cork Branch

Unit 4 Metro Business Park
Ballycurreen
Cork
T12 HP60

Dublin Branch

Unit 19 Naas Road Business Park
Naas Road
Dublin 12
D12 TK88

You can place order via:



www.kdelectronics.ie



sales@kdelectronics.ie



021 4316066 (Cork)
01 6855572 (Dublin)

or via our Mobile Application available
on the App store and Google play

